



**QUICKBLOCK®**

# SECURITY

RAPID ASSEMBLY  
PROTECTIVE  
INFRASTRUCTURE

+44 1786 643 939  
[info@quickblock.uk](mailto:info@quickblock.uk)  
[quickblock.uk](http://quickblock.uk)

---

**QUICKBLOCK®** is a modular, easy-to-use building system delivered in flat-pack form, ideal for rapid assembly and disassembly in various infrastructure and force protection scenarios.

Made from 100% recycled plastic, the QUICKBLOCK interlocking design allows you to stack them as simply / easily as children's building blocks requiring no specialist tools or labour and can be filled with materials for added strength. They are reusable, recyclable, and come in two grades: **QUICKBLOCK** and the **QUICKBLOCK Defence**.

---

#### HOW TO USE QUICKBLOCK

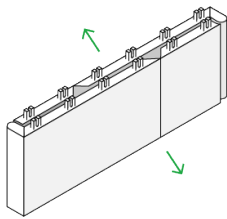

1. OPEN

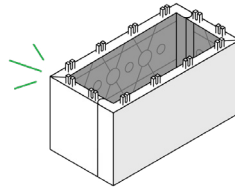

2. CLICK

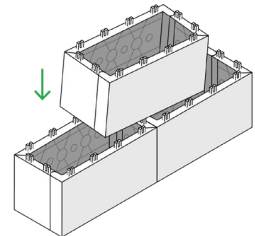

3. BUILD

---

#### BENEFITS OF QUICKBLOCK

01

##### FAST AND EASY ASSEMBLY

No need for specialist skills or tools.

02

##### DURABLE, STRONG AND MADE TO LAST

Undergone extensive impact testing, can withstand 100mph winds, heavy rainfall and provide significant UV protection.

03

##### FLAT-PACKED AND PORTABLE

250 large blocks can be transported on a standard pallet; each block weights 1.2kgs.

04

##### RECYCLED, REUSABLE AND RECYCLABLE

Made from 100% recycled polypropylene.

# QUICKBLOCK VS QUICKBLOCK DEFENCE

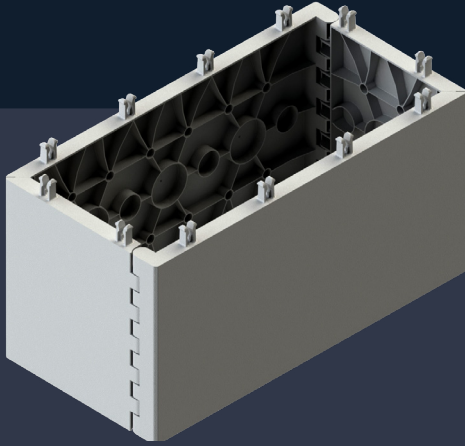

## QUICKBLOCK

**QUICKBLOCK is a rapid assembly building system made from 100% recycled plastic.**

This system is structurally sound and ideal for temporary infrastructure and general engineering across a range of projects. The system can be in-filled with sand or aggregate to offer ballistic and blast protection.

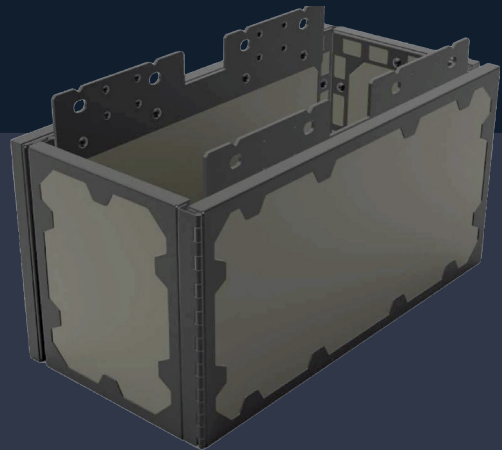

## QUICKBLOCK DEFENCE

**We know keeping your personnel safe is a top priority, that's why we've created the QUICKBLOCK Defence Block.**

Made from lightweight steel and composite ballistic material, that's been successfully tested against blast and ballistic threats. These blocks can provide rapid cover within minutes and weigh less than 7kg per block for easy logistics and assembly.



**RAPID ASSEMBLY & DISASSEMBLY**



**BALLISTIC & BLAST PROTECTION**



**FLEXIBILITY OF STRUCTURES**



**STRONG AND DURABLE**





## USER TRIALS & CASE STUDIES

Our semi-permanent hostile vehicle mitigation solutions are certified by NPSA (formerly CPNI) for safety and security and approved by Secured by Design for enhanced protection. QUICKBLOCK is currently being used for a corridor clearance training environment and violent person extraction room scenario training facility by a UK police force.





### SECURITY TRAINING ENVIRONMENTS

-  assembly 1 day
-  with 6 people





### QUICKBLOCK SHELTER

-  assembly 2 hours
-  with 4 people





### VEHICLE CHECK POINT STRUCTURE

-  assembly 3 minutes
-  with 3 people



### HVM

-  assembly 3 hours
-  with 2 people

QUICKBLOCK offers versatile use cases and custom design solutions, with an in-house team for bespoke projects.

**BUILD TYPE**

**DESCRIPTION**

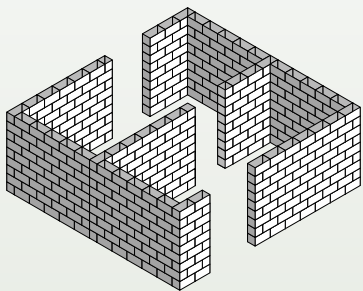

**SECURITY TRAINING ENVIRONMENTS**

As part of your ongoing security personnel training, you can create various training environments including corridor clearance, violent person extraction and any other scenario with QUICKBLOCK's easy-to-assemble, flat-packed and reusable blocks.

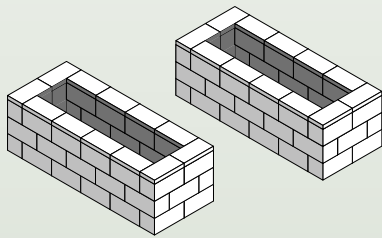

**HOSTILE VEHICLE MITIGATION**

We are proud to offer three impact-rated QUICKBLOCK planters designed to enhance security. When filled with aggregate, these planters serve as reliable barriers against vehicle attacks while doubling as functional street furniture.

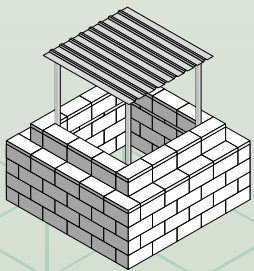

**FORCE PROTECTION & INFRASTRUCTURE**

QUICKBLOCK provides adaptable, reusable, and protective force protection products that are durable, lightweight, easy to assemble without tools, and offer ballistic and blast protection with local infill.

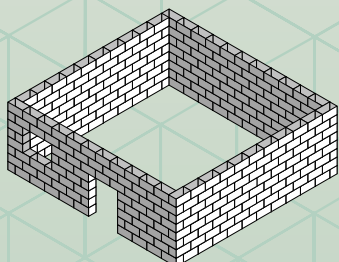

**GENERAL INFRASTRUCTURE**

QUICKBLOCK's general infrastructure capabilities include humanitarian response structures, building repair and safeguarding, retaining walls, revetments, and storage facilities for supply chain lines.

# QUICKBLOCK® DATA SHEET

QUICKBLOCK is a rapid assembly building system made from 100% recycled plastic.

This system is structurally sound and ideal for temporary infrastructure and general engineering across a range of projects. The system can be in-filled with sand or aggregate to offer ballistic and blast protection.

## KEY FEATURES

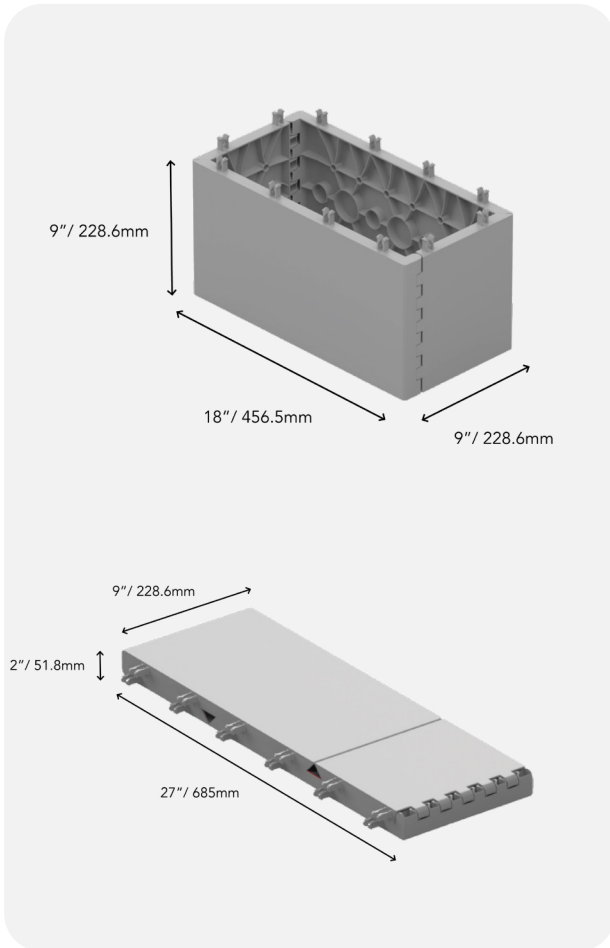

- Easy to use, intuitive design means anyone can build with QUICKBLOCK
- Made from 100% recycled plastic
- Very lightweight (less than 1.2kg per block)
- Flat-packed in deployment (250 blocks on NATO pallet)
- Ballistic resistance across multiple weapons when tested with sand and aggregate infill (full report available)\*
- Multi-hit performance
- Blast resistance – successfully tested with 60mm mortar\*
- QUICKBLOCK patented cell structure means threat is isolated to one part of the structure and damaged blocks can be replaced
- Training Required: 1 minute video tutorial available or simple instruction manual
- Colours (Light Grey and Olive Green)

**Scenario: Rapid assembly infrastructures, more time required to infill structure with sand/aggregate if additional protection is necessary.**

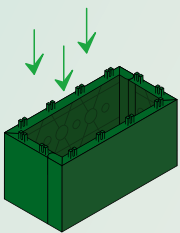

### VERTICAL LOAD BEARING

Test conducted by applying force downward

**Max load - 1.6t (16.4kN)**

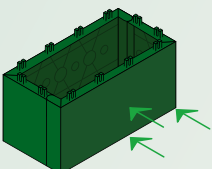

### HORIZONTAL COMPRESSION

Test conducted by applying force perpendicular

**Max load - 0.36t (3.6kN)**

## MATERIAL MECHANICAL PROPERTIES

QUICKBLOCK is made from 100% recycled polypropylene

Tensile Strength	28 MPa
Tensile Elongation	>150%
Tensile Modulus	1241 MPa
Flexural Strength	41 MPa
Flexural Modulus	1379 MPa
Rockwell Hardness/ R value	90

# QUICKBLOCK® DEFENCE DATA SHEET

QUICKBLOCK Defence is a rapid assembly building system made from lightweight steel and composite ballistic material.

Developed specifically for military use, it is structurally sound and offers ballistic and blast protection without additional infill. Ideal for rapid deployment scenarios where cover is required within minutes.

## KEY FEATURES

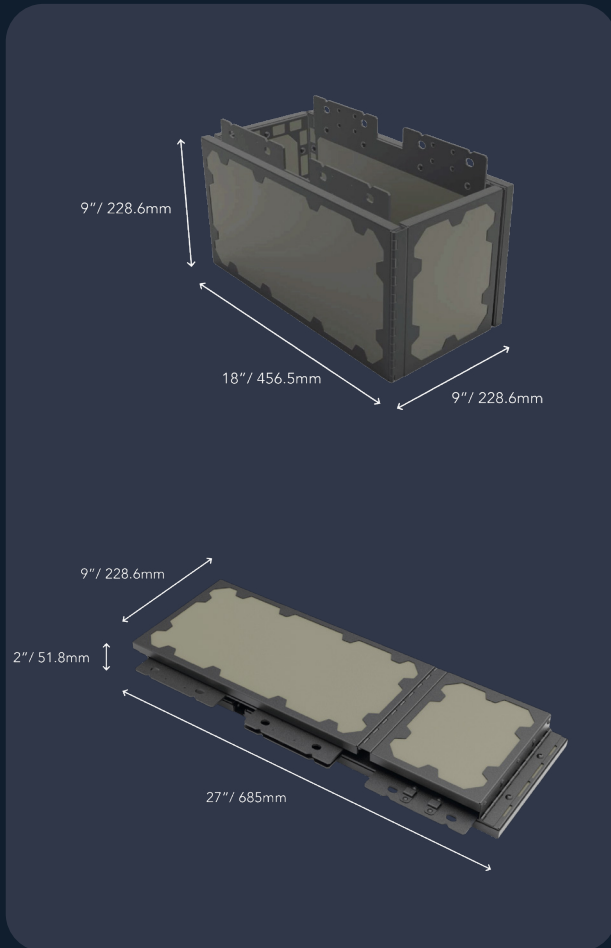

- Easy to use, intuitive design means anyone can build with QUICKBLOCK Defence
- Made from lightweight steel and composite ballistic material (less than 7kg per block)
- Flat-packed in deployment
- Successful ballistic testing against 7.62x51 NATO Ball M80 and 7.62x39 PS Ball (MSC) threats
- Multi-hit performance
- Blast resistance - successfully tested with FSP and live fire testing with 60mm mortar\*
- Tie down – ability to tether the structure to ground to increase blast performance
- QUICKBLOCK patented cell structure means damage is isolated to one part of the block and panels can be replaced
- Training Required: 1 minute video tutorial available or simple instruction manual
- Colours (NATO Green, other options available on request)

**Scenario: Rapid assembly with no need to infill for ballistic and blast protection. 3 person VCP unit can be built in 2 mins.**

## CASE STUDIES



### QUICKBLOCK DEFENCE Vehicle Checkpoint Assembly

- ✔ VCP (L shaped structure) - protective cover for 3 people.
- ✔ Assembly time 3 minutes, disassembly time 2 minutes.



Designed in Scotland.



Contact us to discuss your  
QUICKBLOCK Security project  
on **+44 1786 643 939**  
or email us on **info@quickblock.uk**  
**quickblock.uk**