

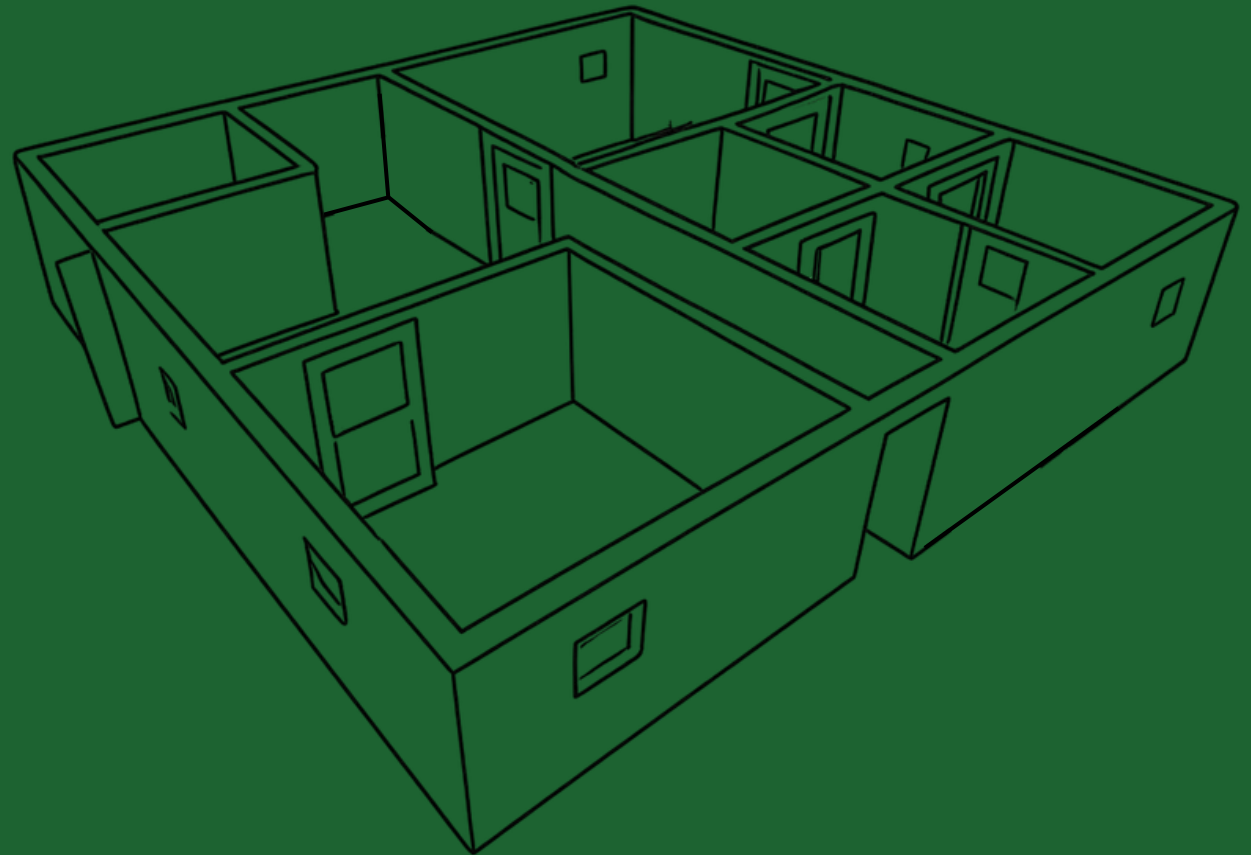

INSTRUCTIONS
TACTICAL TRAINING ENVIRONMENT
BRAVO KIT



Follow the QUICKBLOCK instructions when building ensuring all blocks are locked firmly in place.

Use hard hats, eye protection, and appropriate footwear during construction.

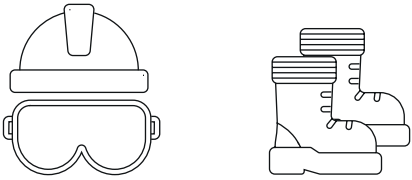

Be aware of fingertraps when opening and closing the blocks, we recommend users wear gloves when building with QUICKBLOCK.

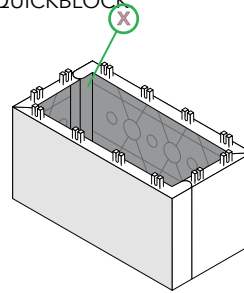

Do not construct above 12 blocks in height without advice from qualified personnel.

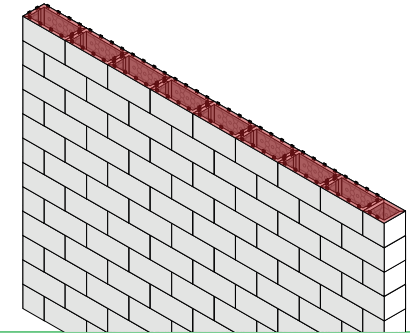

For long walls, strengthen with right angles buttressing (at 2m intervals) or integrate rooms / corners to provide stability.

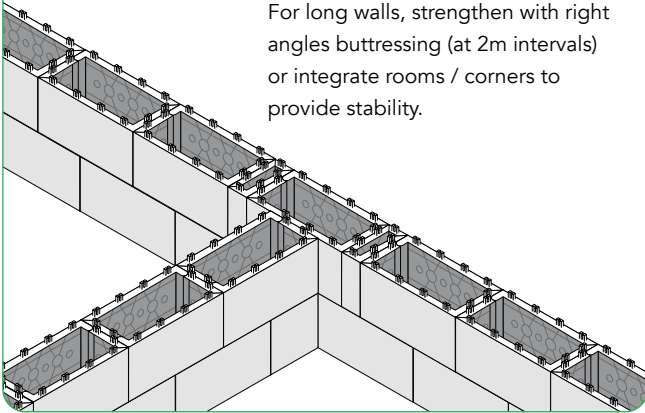

Do not climb or place heavy loads on QUICKBLOCK walls unless rated for it.

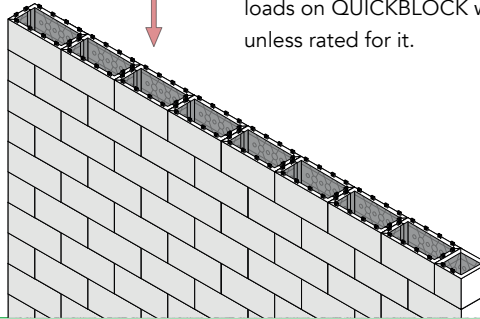

Where possible, construct on level and stable ground.

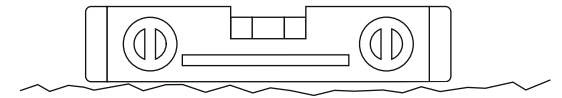

Avoid using blocks in ways not intended by the manufacturer. For more info, see the instruction manual.



OPEN

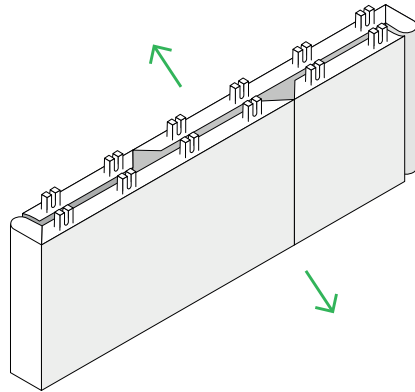

CLICK

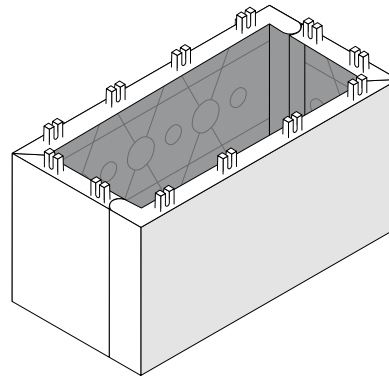

BUILD

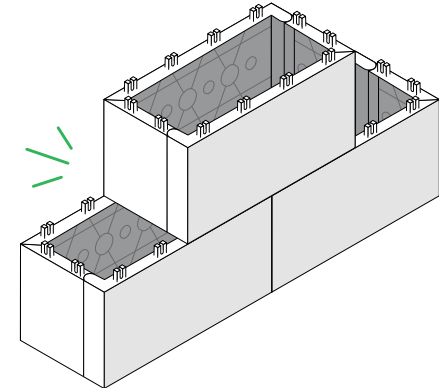

Opening blocks with excess force may result in blocks becoming damaged. It is recommended that blocks are opened with two hands and moderate force. QUICKBLOCK does not accept responsibility for blocks that are broken due to user error.



BRAVO TRAINING KIT

TACTICAL TRAINING ENVIRONMENT

QUICKBLOCK Tactical Training Kits are designed to be assembled layer by layer, guiding you step-by-step through a straightforward and intuitive build process.

- Block type key is included on each page.
- MoE door placements included.
- 'How to' for building lintels for the doors included.



STEP 1 - FIRST LAYER

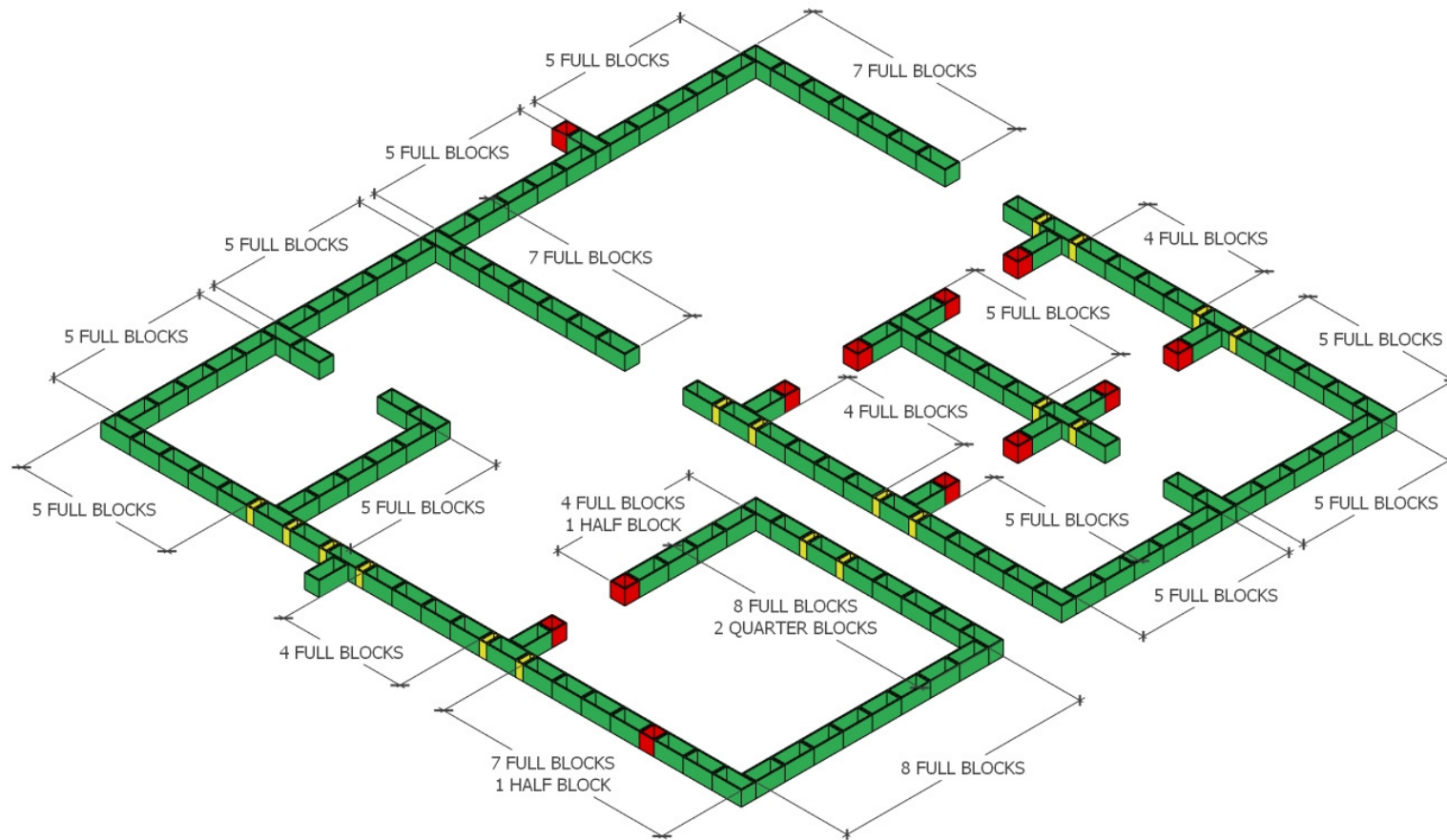

BLOCK TYPE KEY:

- FULL BLOCK
- HALF BLOCK
- QUARTER BLOCK

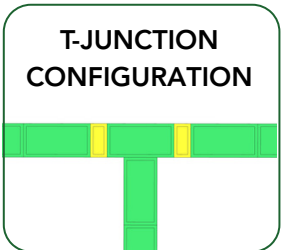

Build the first layer as above on flat ground.





Detailed MoE Door instructions are included with your kit.

STEP 2

Assemble your doors using the included instructions in the spaces provided in the first layer.

STEP 3

Ensure surrounding blocks sit flush against base of door on both sides before building next layer.

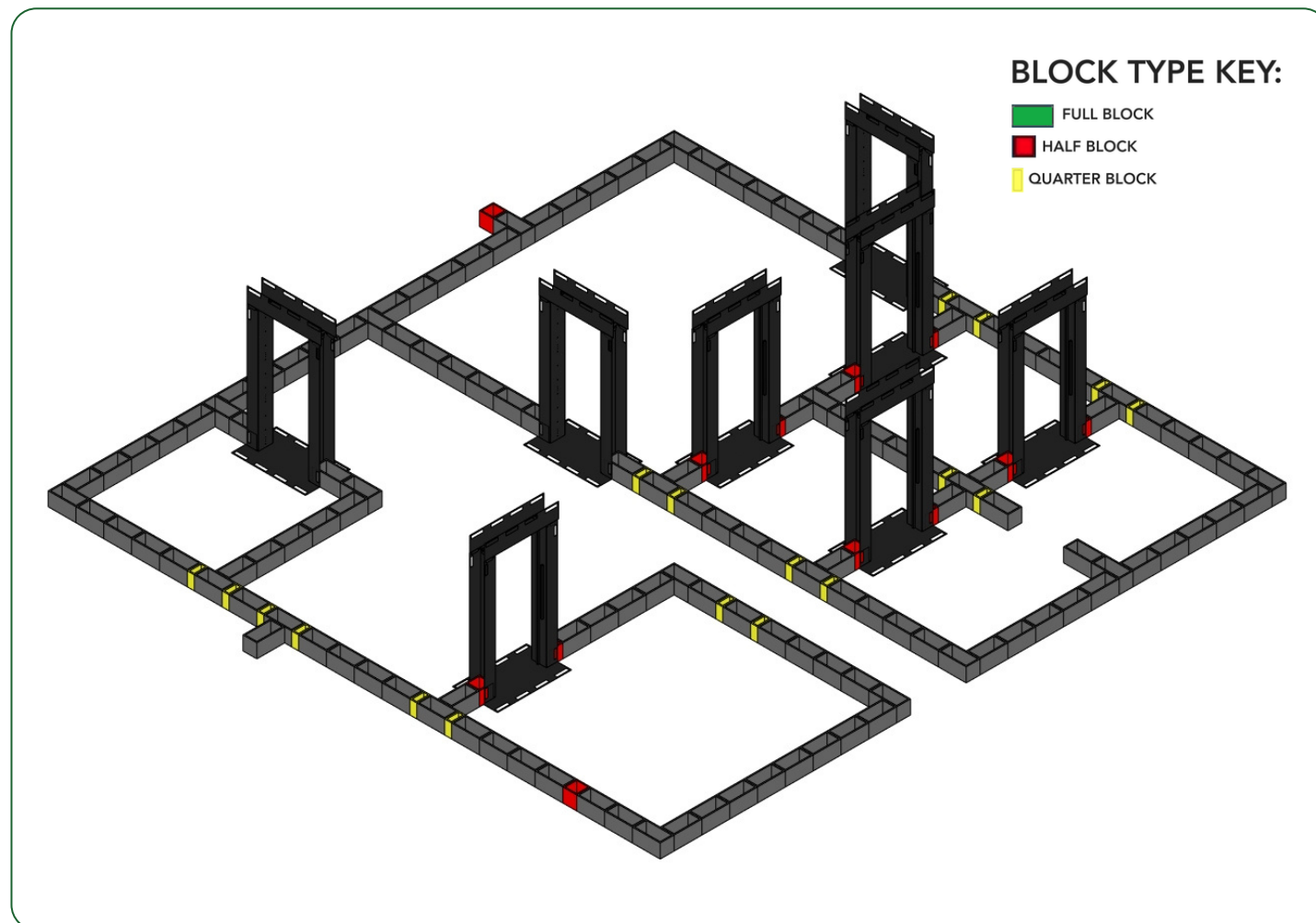

MoE doors have been hidden in further steps for clarity - do not remove during build.



STEP 4 - LAYER 2

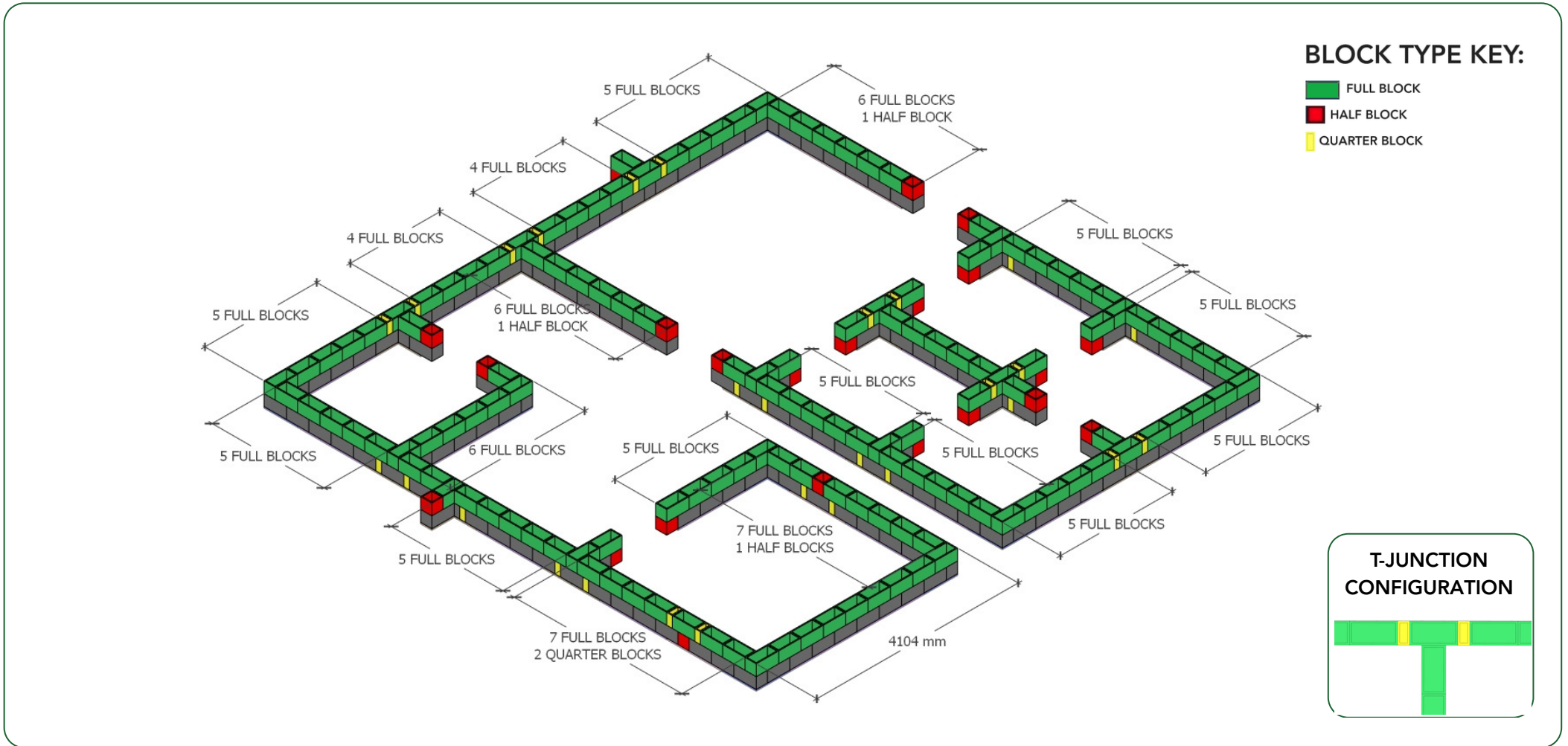

! MoE doors have been hidden in further steps for clarity - do not remove during build.



STEP 5 - LAYER 3

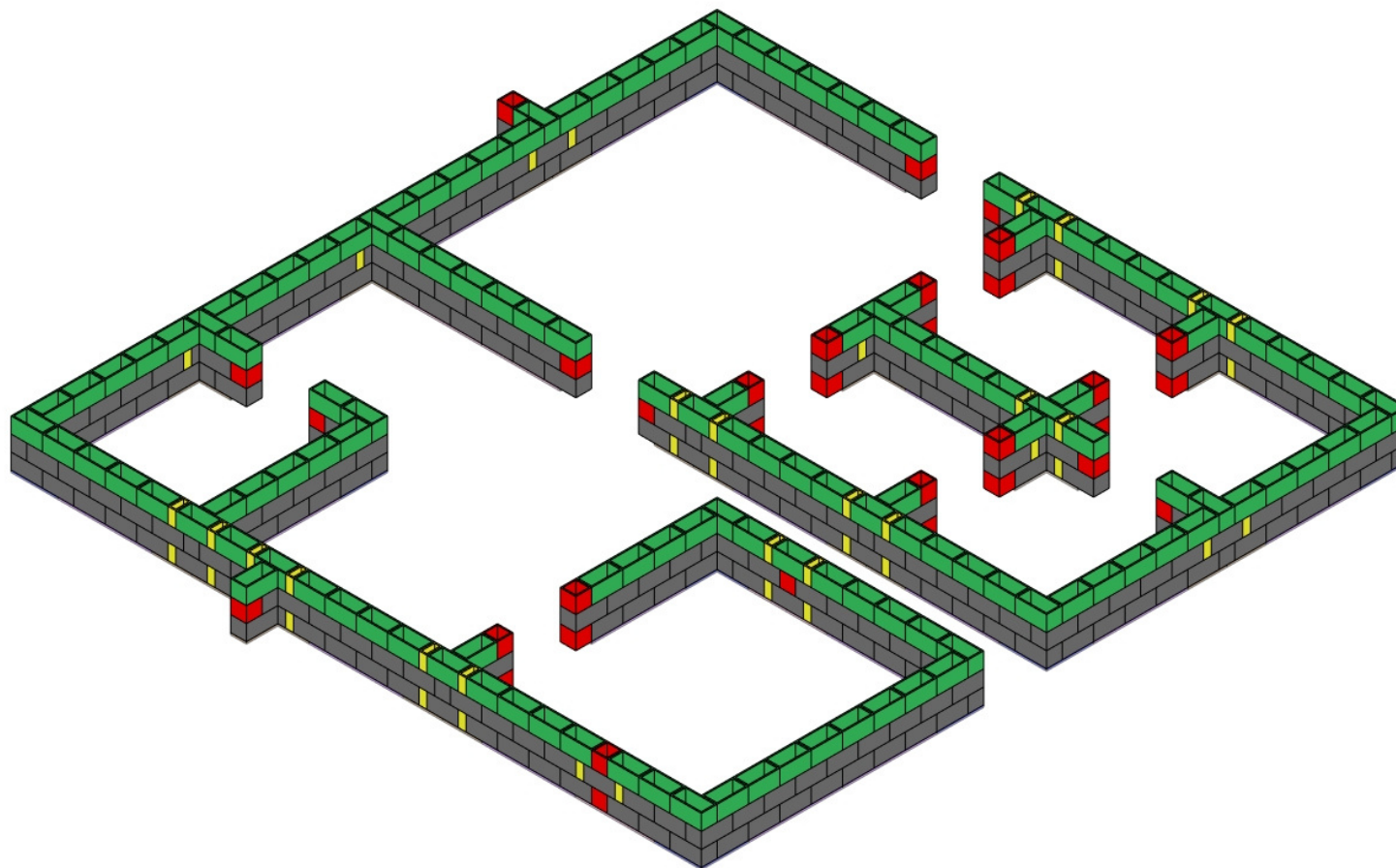

BLOCK TYPE KEY:

-  FULL BLOCK
-  HALF BLOCK
-  QUARTER BLOCK



STEP 6 - LAYER 4

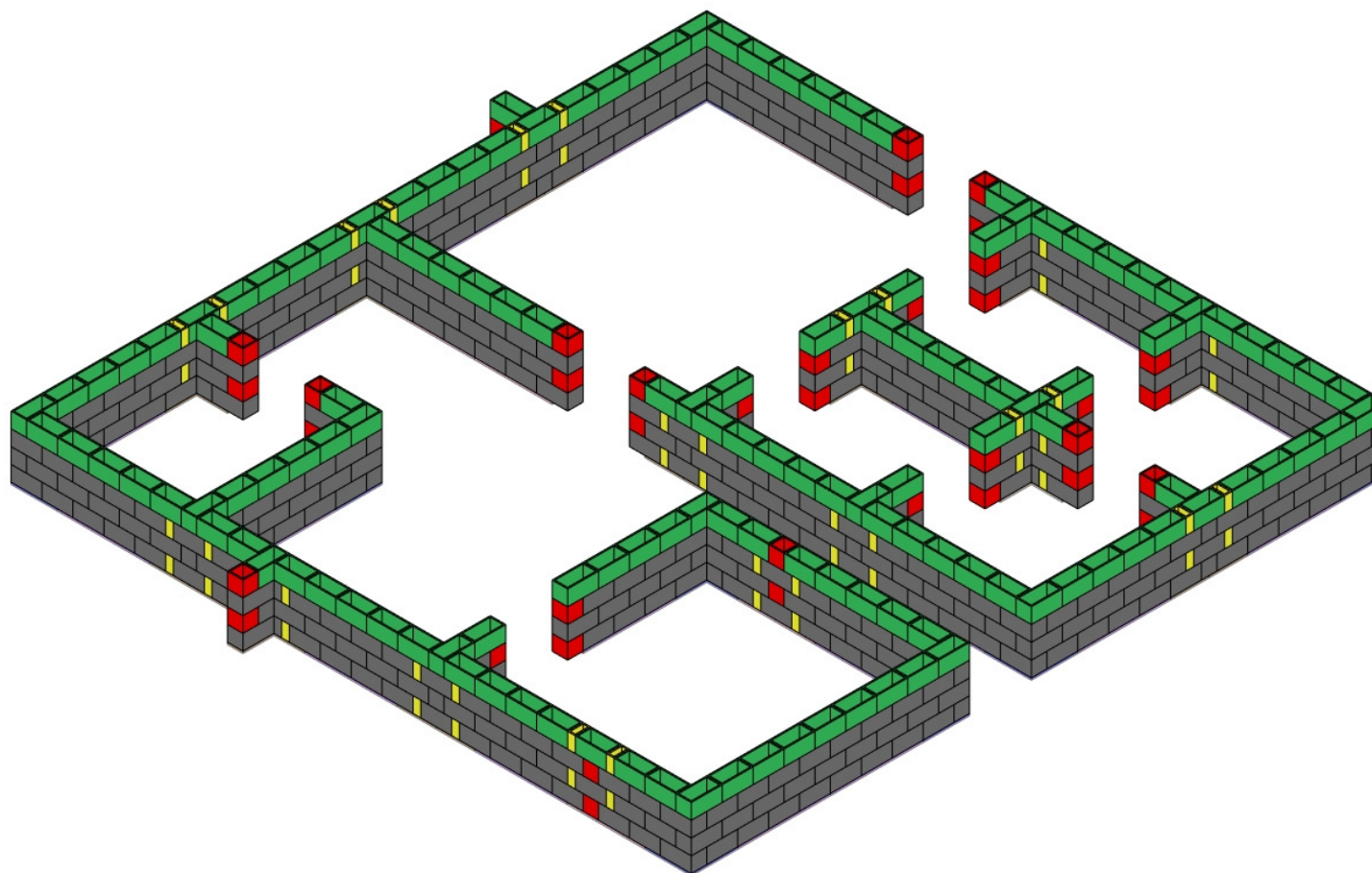

BLOCK TYPE KEY:

-  FULL BLOCK
-  HALF BLOCK
-  QUARTER BLOCK



STEP 7 - LAYER 5

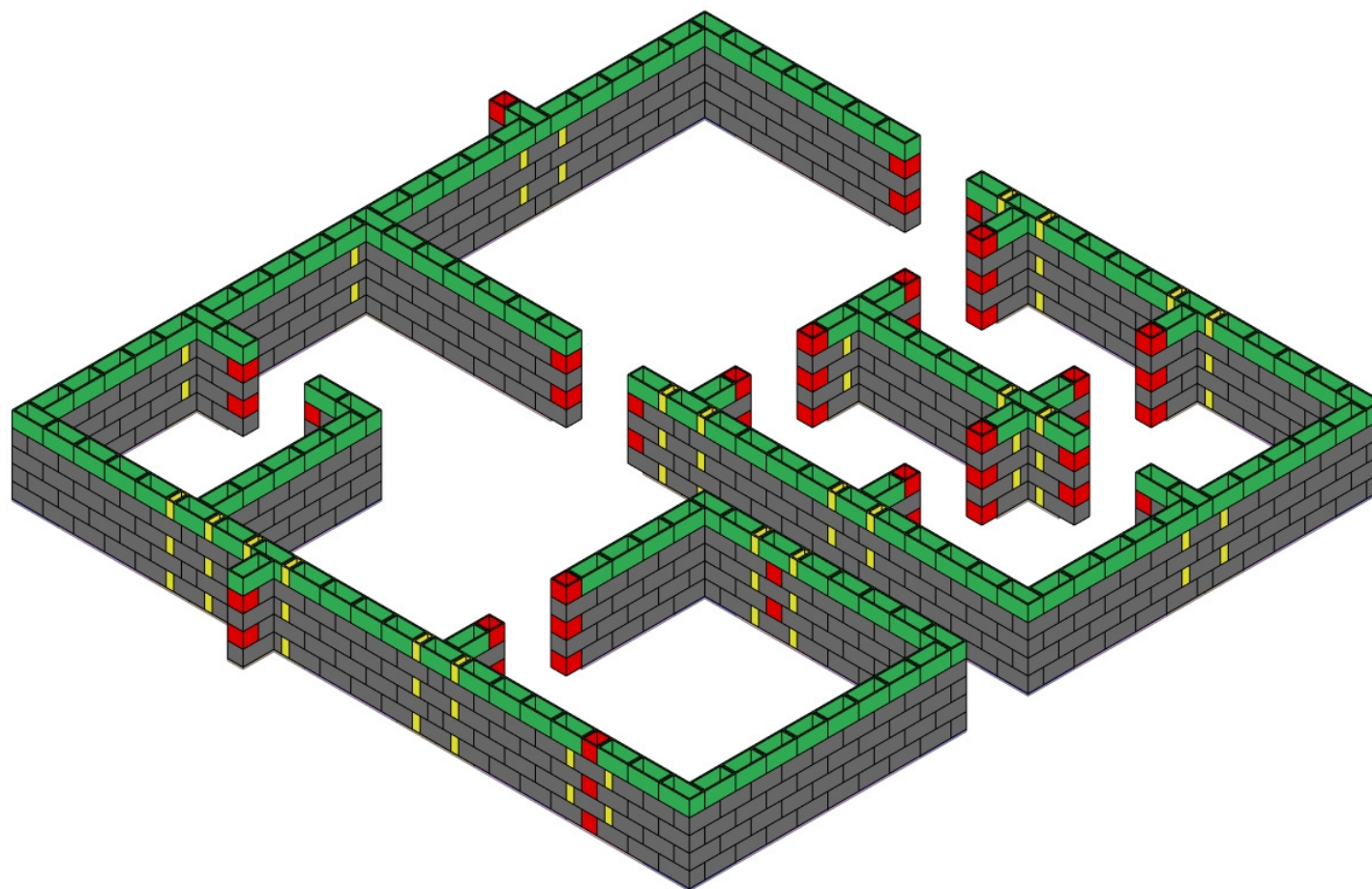

BLOCK TYPE KEY:

-  FULL BLOCK
-  HALF BLOCK
-  QUARTER BLOCK



STEP 8 - LAYER 6

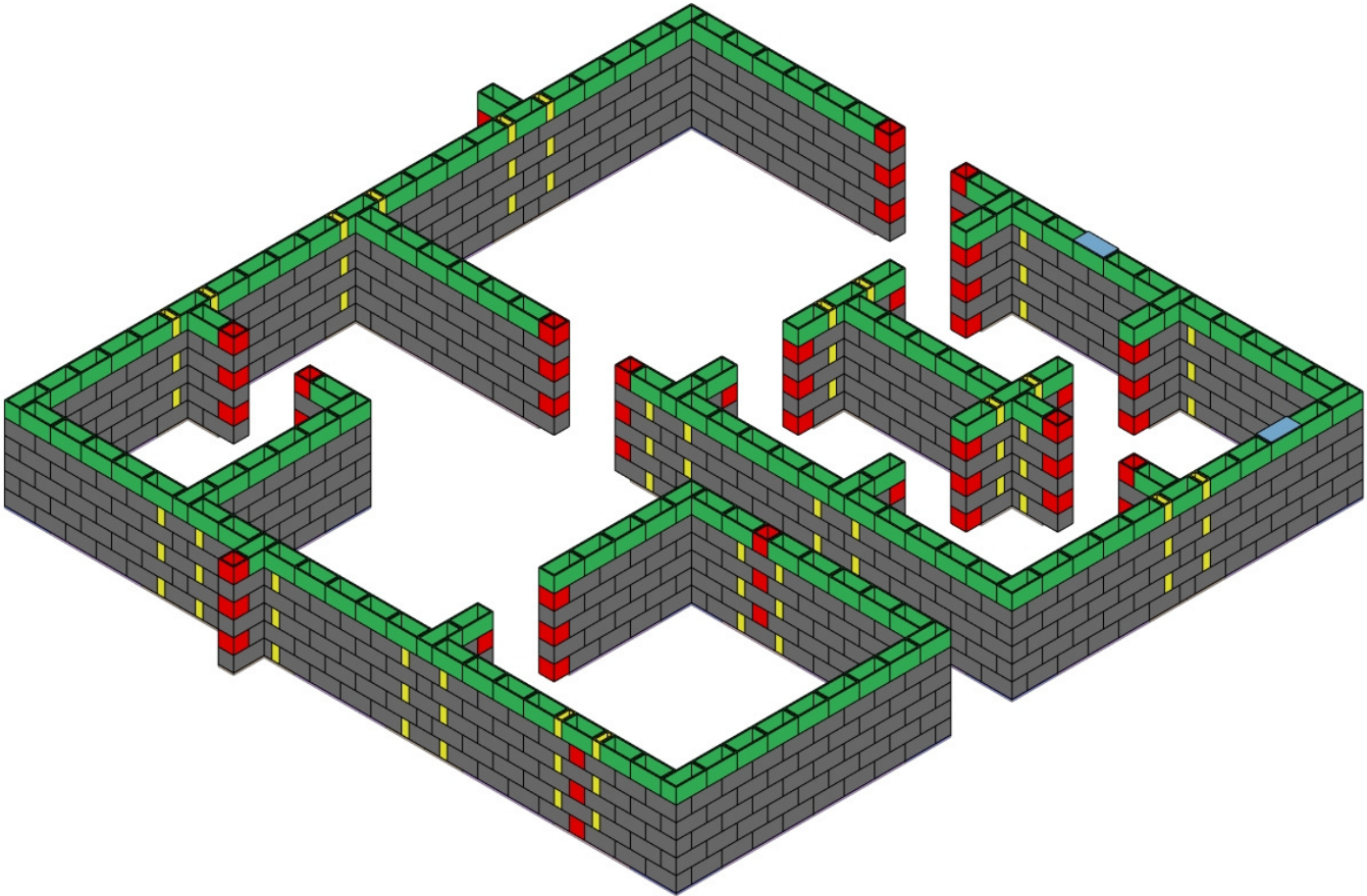

BLOCK TYPE KEY:

-  FULL BLOCK
-  HALF BLOCK
-  QUARTER BLOCK





CAPPING PIECE

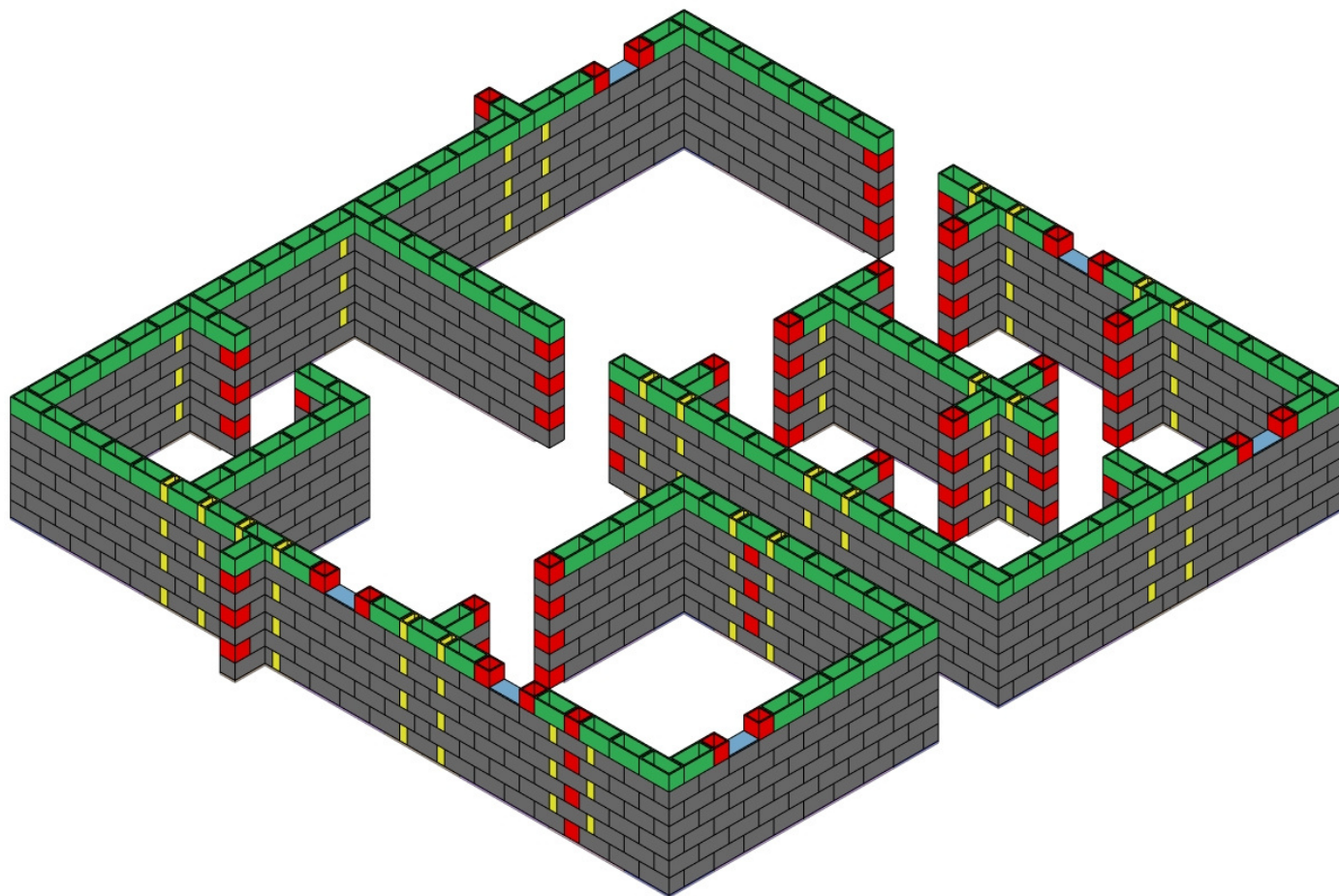

STEP 9 - LAYER 7



BLOCK TYPE KEY:





-  FULL BLOCK
-  HALF BLOCK
-  QUARTER BLOCK
-  CAPPING PIECE

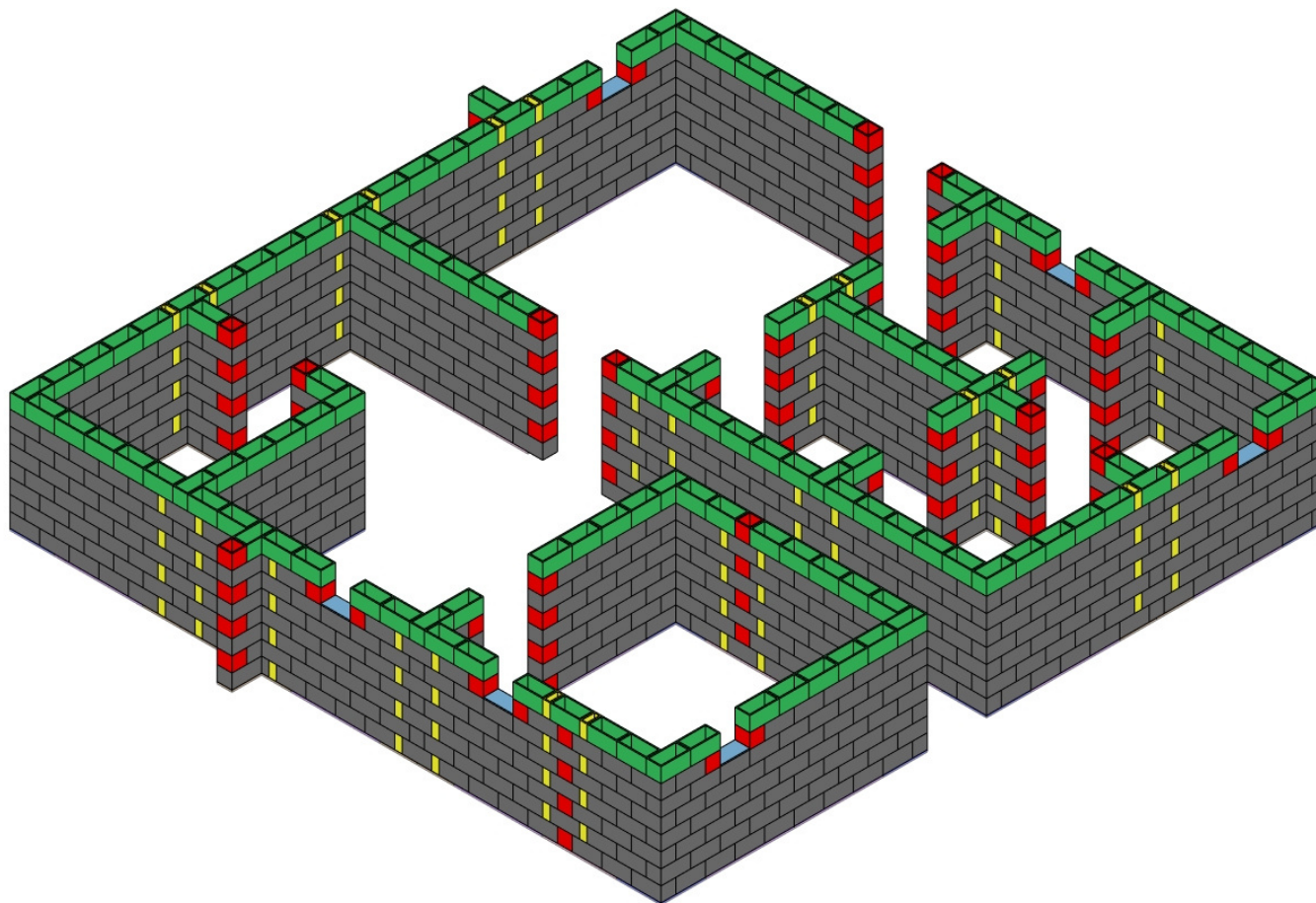

STEP 10 - LAYER 8



BLOCK TYPE KEY:

-  FULL BLOCK
-  HALF BLOCK
-  QUARTER BLOCK
-  CAPPING PIECE

WINDOW SPACE

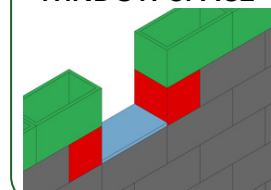

ADDING QUICKBLOCK WINDOWS



QUICKBLOCK windows are created using 2 identical panels.

STEP 11

Before placing in window space, use provided black fir-tree clips to connect the two panels through the 8 holes and push together.

STEP 12

Slide all windows into the allocated spaces as shown in the drawing.

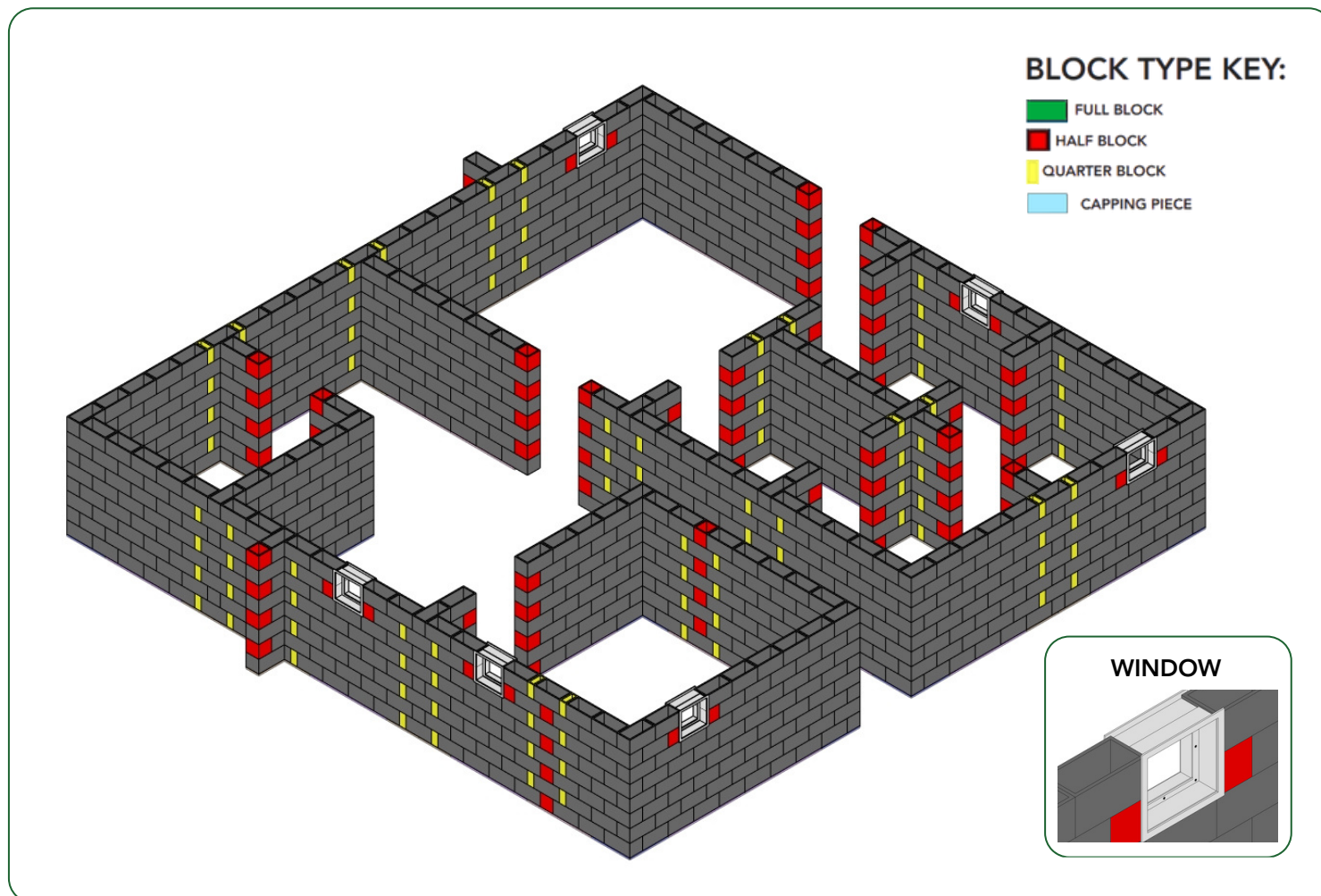

PREPARING CAPPING PIECES FOR LINTELS



Detailed lintel instruction pack is included with your kit.

STEP 13

Flip Capping Piece over, revealing slots. Push 8 QUICKBLOCK clips down into the slots around outside of capping piece as shown.

STEP 14

Push 8 QUICKBLOCK pins into corresponding holes around the outside of the Capping Piece. Make sure the head of pin sits flush with the surface around it.

STEP 15

Create 26 lintel Capping Pieces for this structure

13

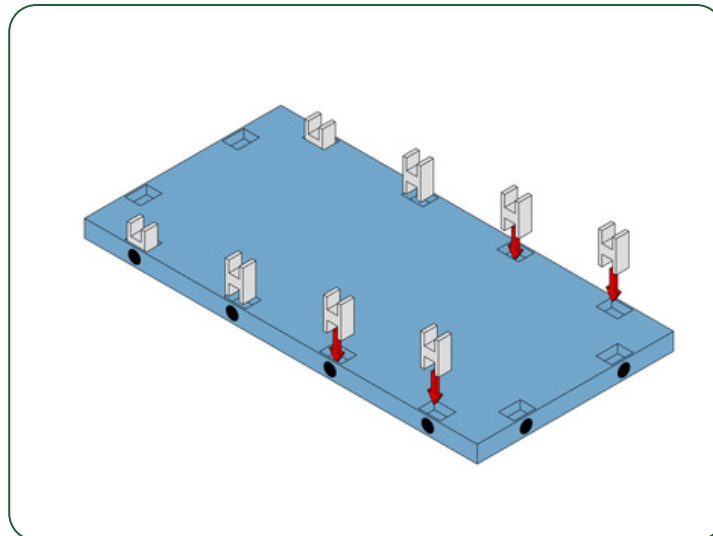

14

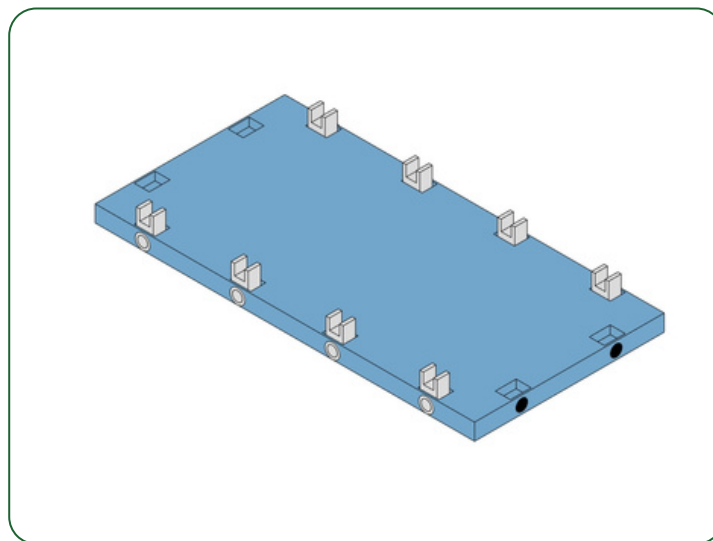
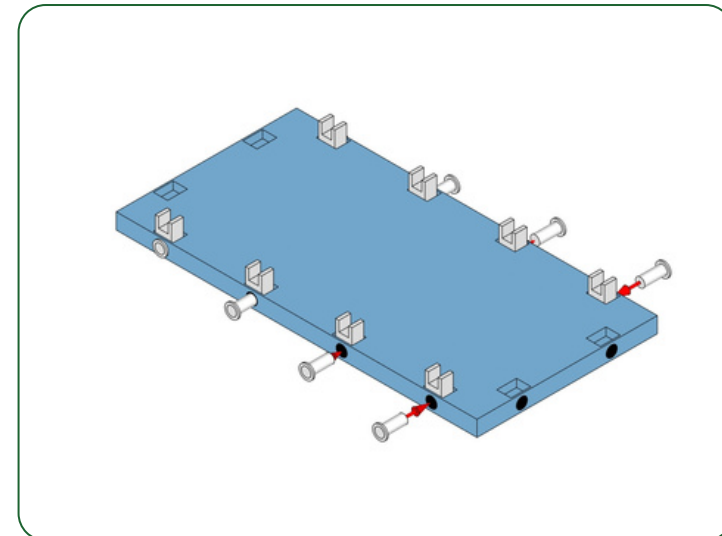

15

CLIPS



PINS



CREATING WINDOW LINTEL



Detailed lintel instruction pack is included with your kit.

STEP 16

Insert lintel Capping Piece prepared previously into underside of two Full Blocks, in bricklaying style as shown.

STEP 17

Look down into the window lintel from above and using 8 QUICKBLOCK Pins, secure the points at which the clips come up and into the blocks, by pushing the pins through the hole and clip in locations shown.

STEP 18

Using 6 of the lintel Capping Pieces previously created, and 12 Full Blocks, construct 6 of these window lintels.

16

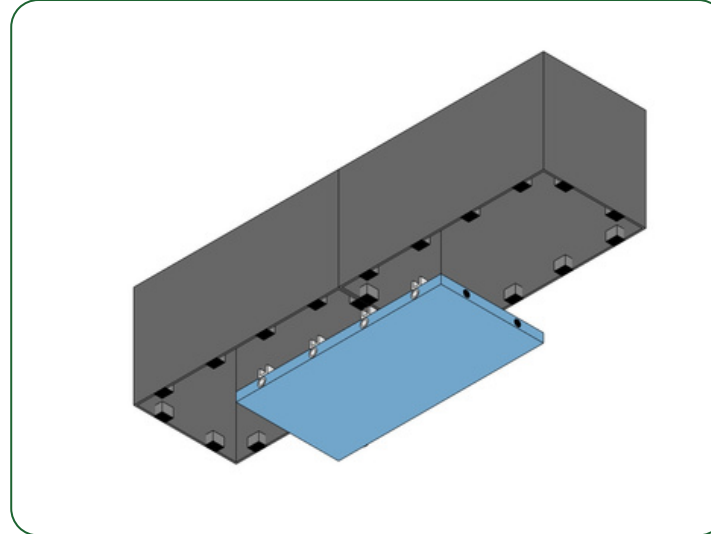

17

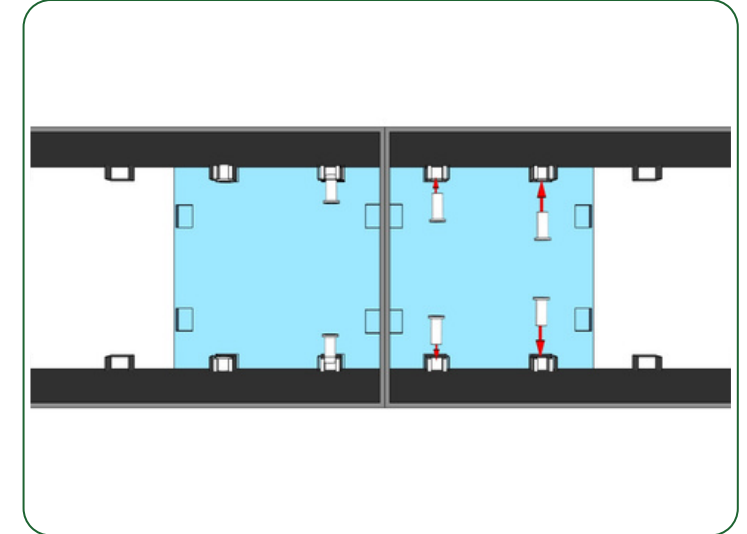

TOP OF BLOCK VIEW

18

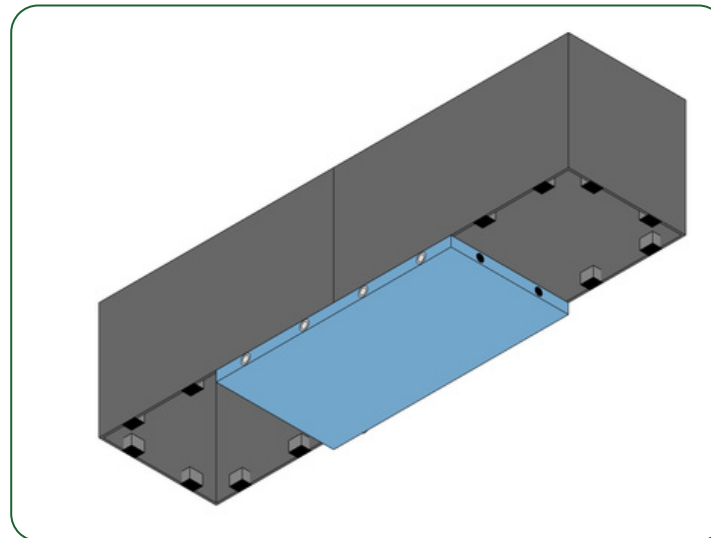

UNDERSIDE OF BLOCK VIEW

WINDOW LINTEL LOCATIONS

STEP 19



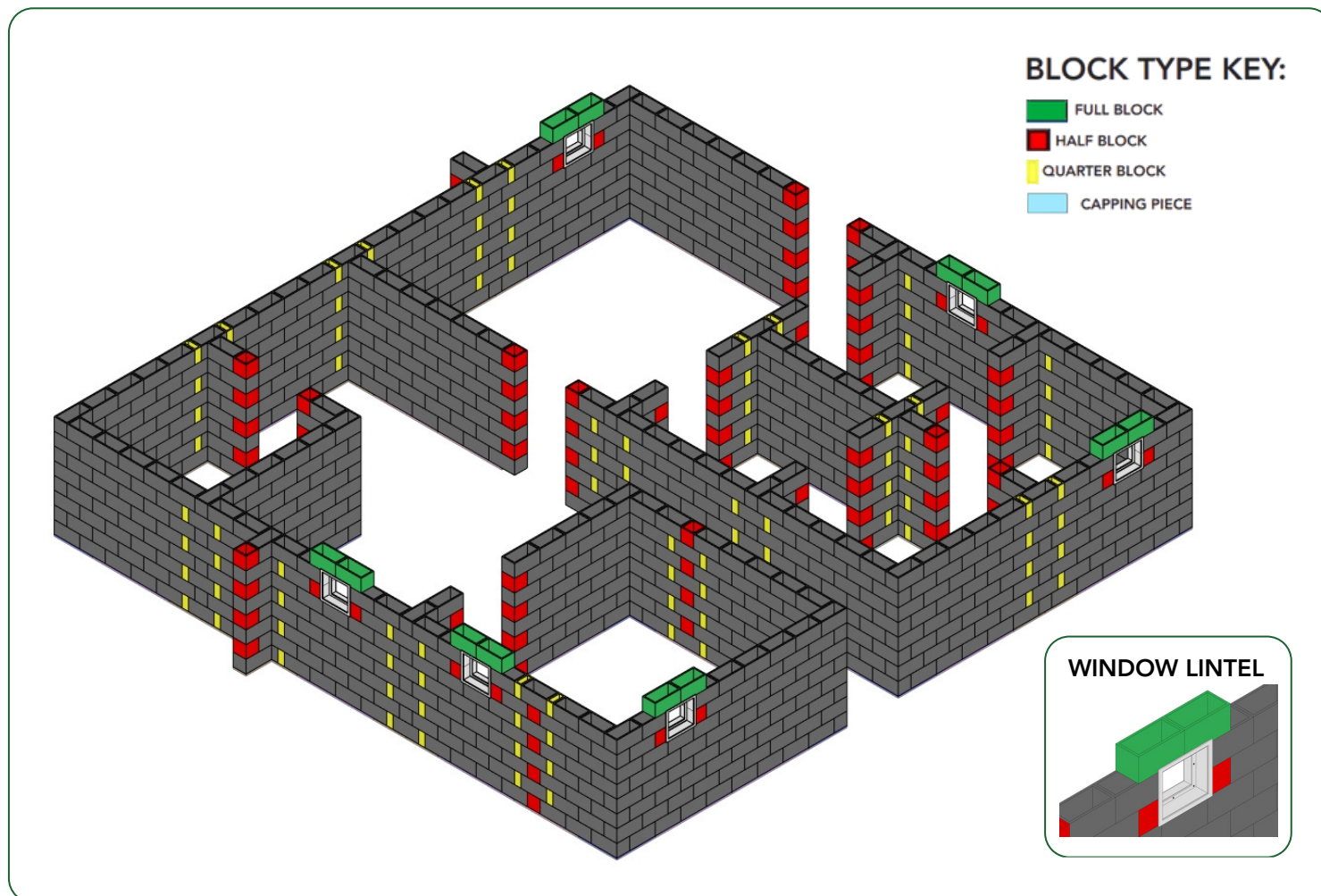

Place pre-made window lintels across window spaces, where shown.

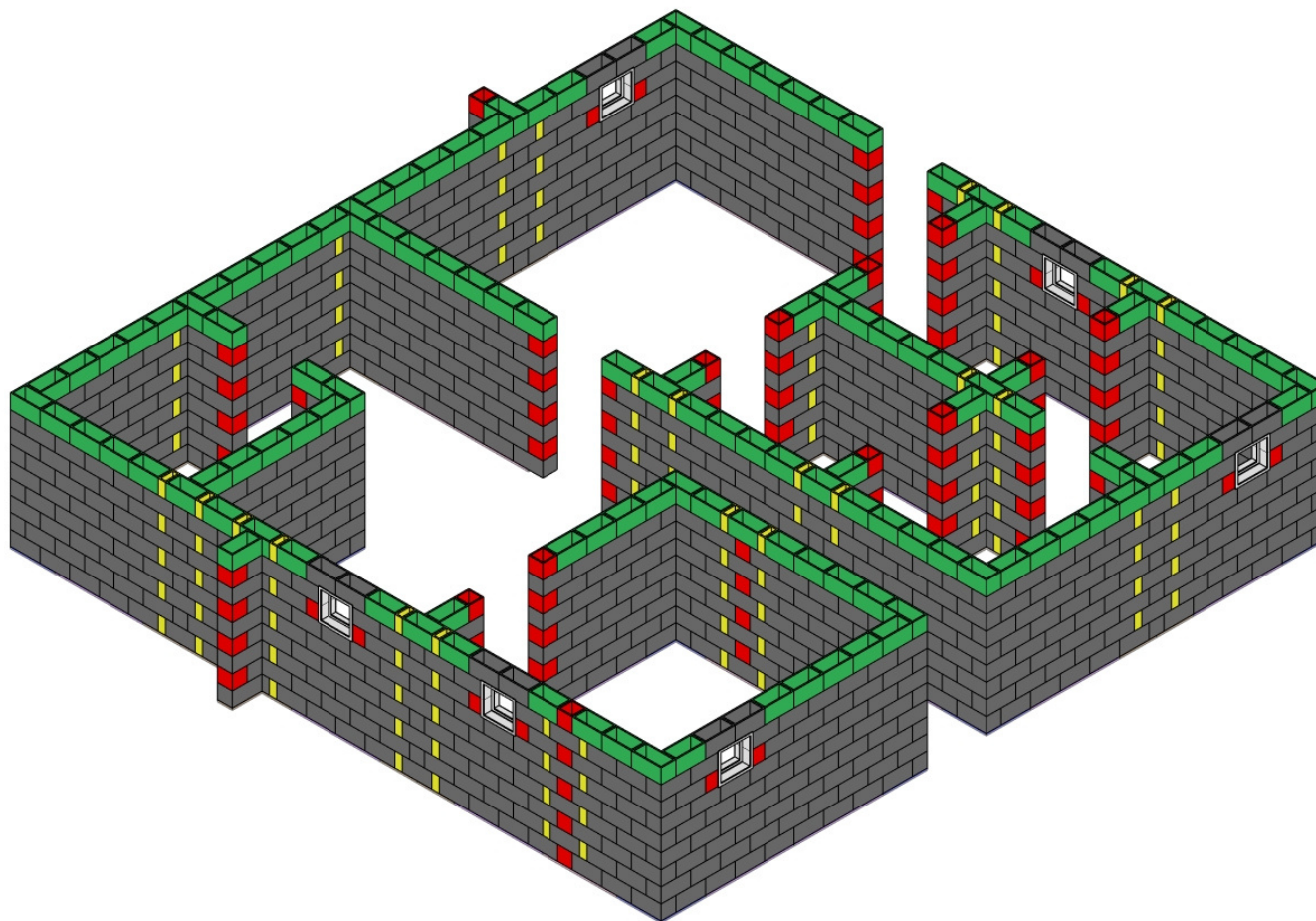

STEP 20 - LAYER 9



BLOCK TYPE KEY:

-  FULL BLOCK
-  HALF BLOCK
-  QUARTER BLOCK
-  CAPPING PIECE



CREATING DOOR LINTEL - VARIATION A 21



There are **2** different door lintels that are required to be built. **4** of variation **A** and **6** of variation **B**.

STEP 21

Insert 2 lintel Capping Pieces prepared previously into underside of three Full Blocks, in bricklaying style as shown.

STEP 22

Look down into the door lintel from above. Using 16 QUICKBLOCK Pins, secure the points at which the clips come up and into the blocks, by pushing the pins through the hole and clip in locations shown.

STEP 23

Using 8 of the lintel Capping Pieces previously created, and 12 Full Blocks, construct 4 of these door lintels.

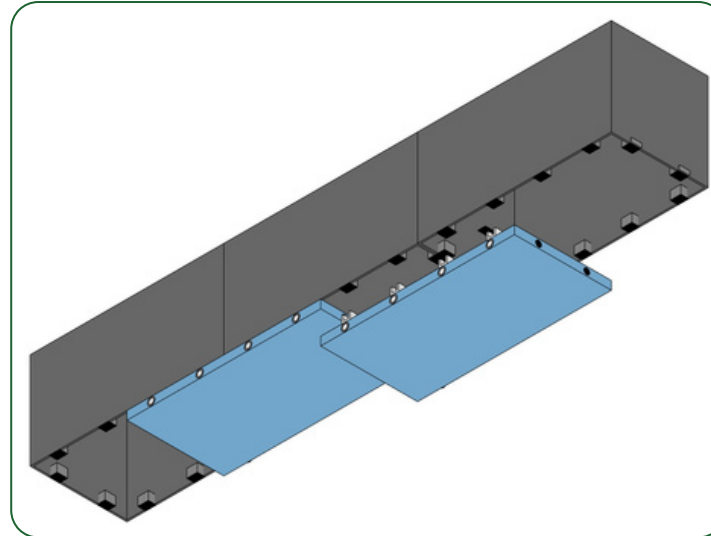

22

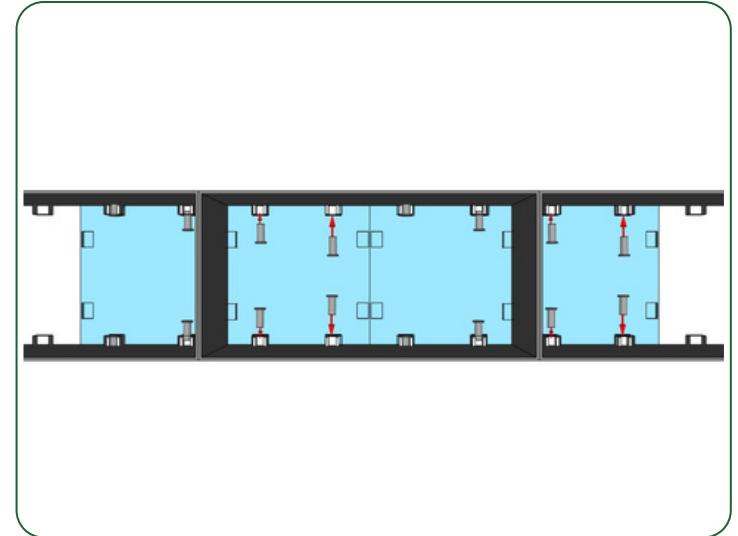

TOP OF BLOCK VIEW

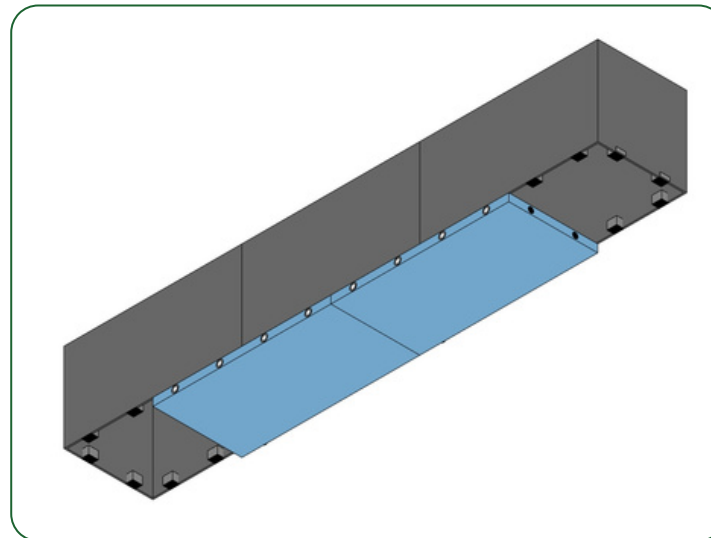

23

UNDERSIDE OF BLOCK VIEW

CREATING DOOR LINTEL - VARIATION B 24



There are **2** different door lintels that are required to be built. **4** of variation **A** and **6** of variation **B**.

STEP 24

Insert 2 lintel Capping Pieces prepared previously into underside of three Full Blocks and two Quarter Blocks, in bricklaying style as shown.

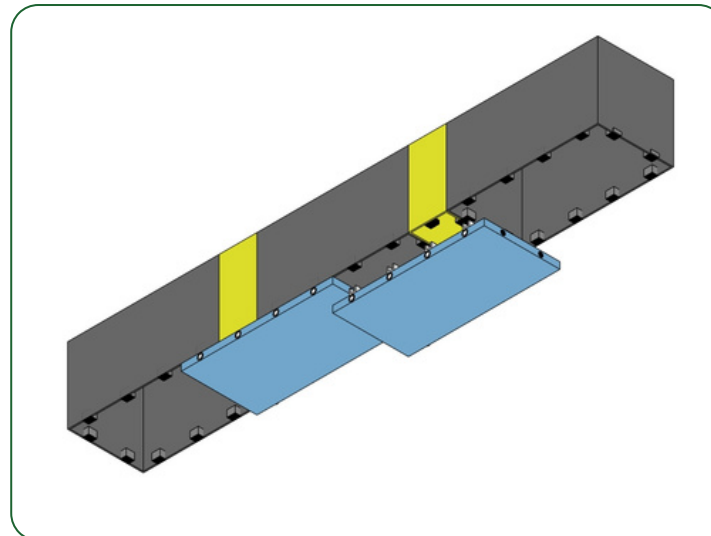

STEP 25

Look down into the door lintel from above. Using 16 QUICKBLOCK Pins, secure the points at which the clips come up and into the blocks, by pushing the pins through the hole and clip in locations shown.

STEP 26

Using 12 of the lintel Capping Pieces previously created, 18 Full Blocks and 12 Quarter Blocks, construct 6 of these door lintels.

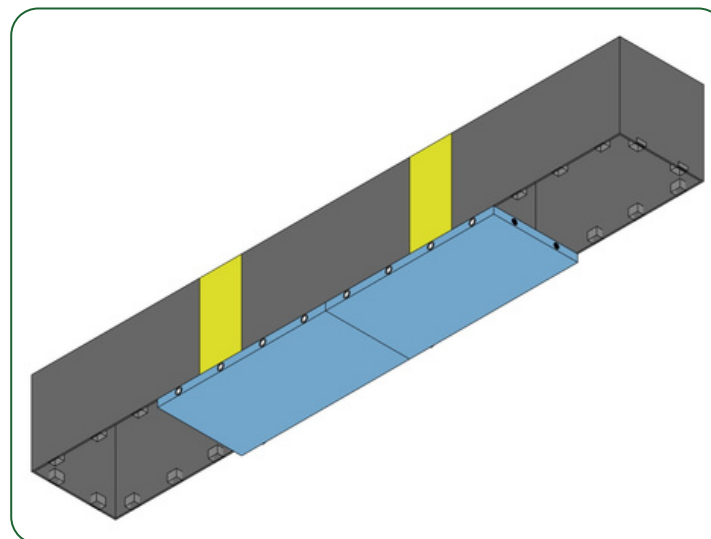

26

UNDERSIDE OF BLOCK VIEW

25

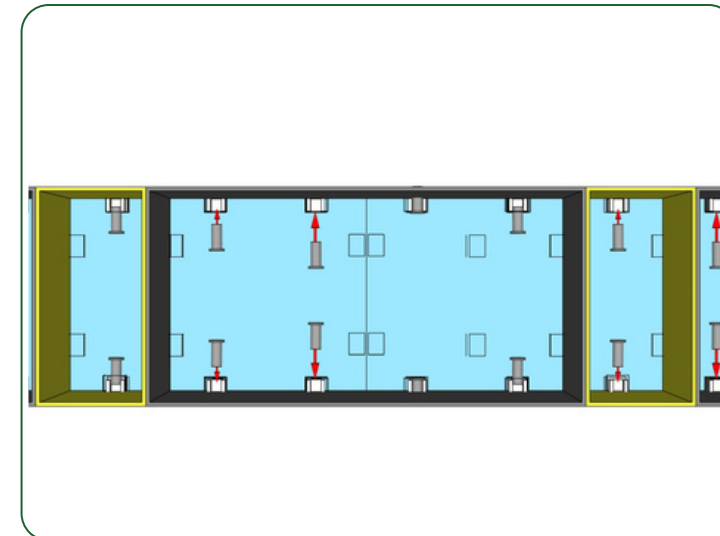

TOP OF BLOCK VIEW

DOOR LINTEL LOCATIONS

STEP 27

Place pre-made door lintels across doorway gaps, using asterisks shown as reference for which variation to use in each location.

STEP 28

Ensure the two capping pieces on the underside sit flush against the Blocks on the sides of the doorway once in place.

DOOR LINTEL VA

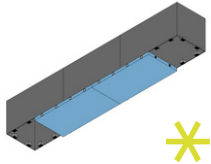

DOOR LINTEL VB

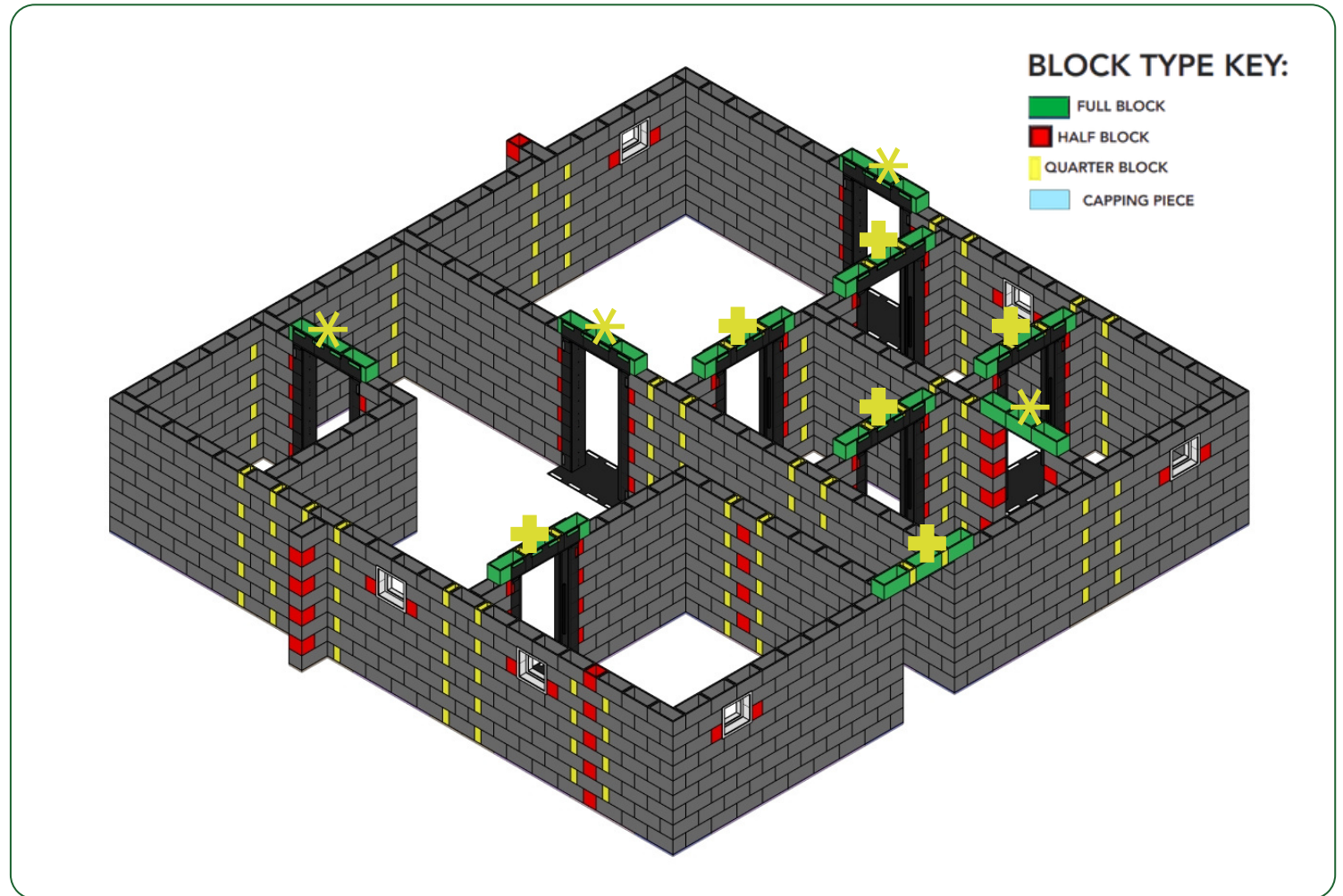
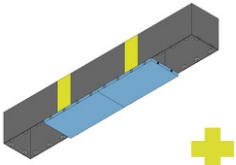

! MoE doors shown for clarity.



STEP 29 - LAYER 10

STEP 30

Looking down from above - use **1340 Pins** as shown to lock layers 9 & 10 together INCLUDING DOOR LINTELS (where they connect to layer 9).

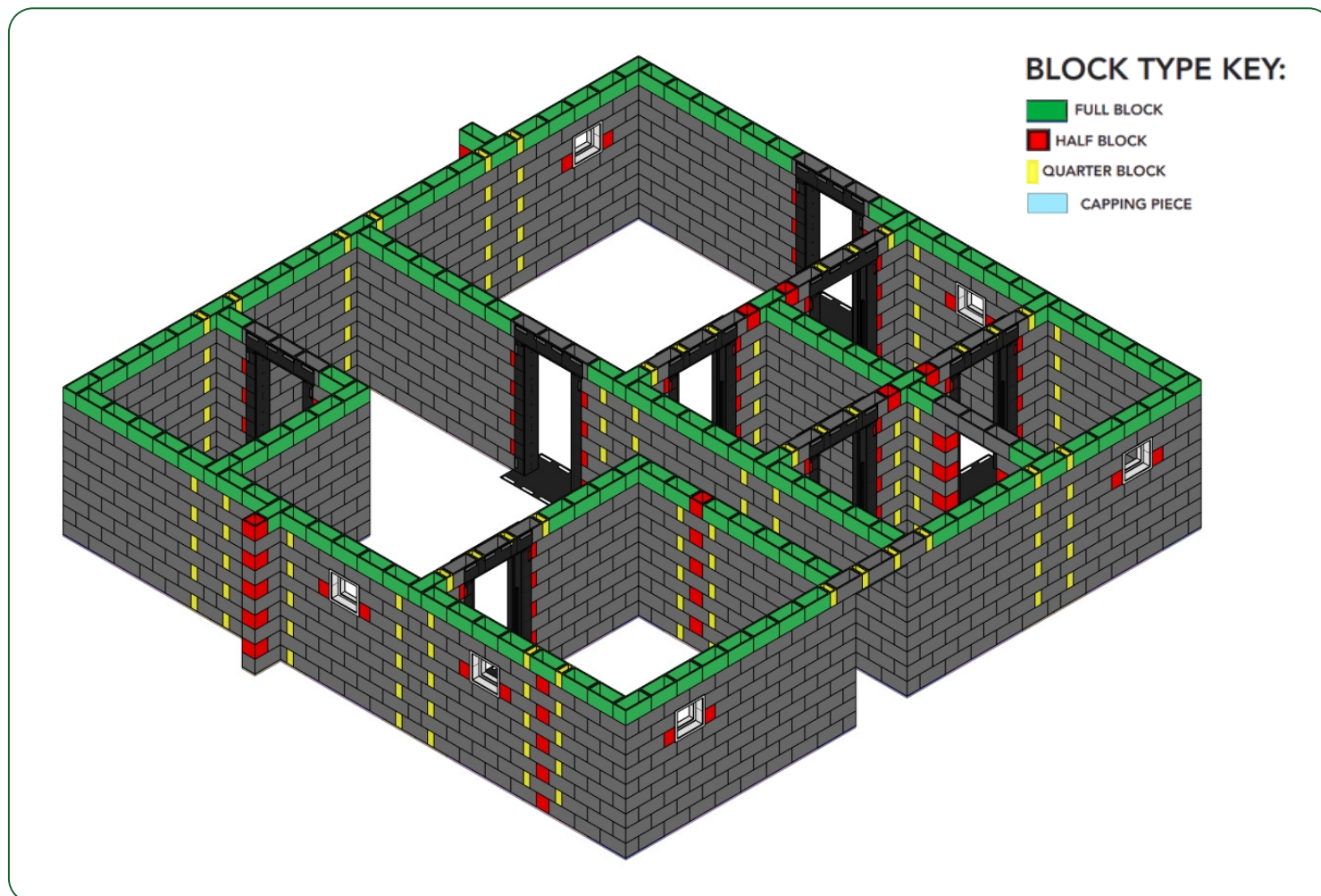
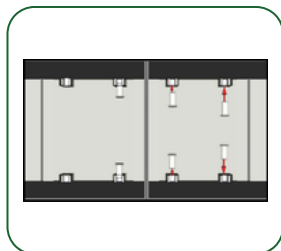

CAPPING PIECE LAYOUT



To create a Half-Block Capping Piece, simply snap a full Capping Piece over your knee.

STEP 31

Place Capping Pieces over top of fixing plates in the layout shown here.

STEP 32

Where interference with threaded rod occurs, snip/cut the threaded rod directly above the bolt.

