

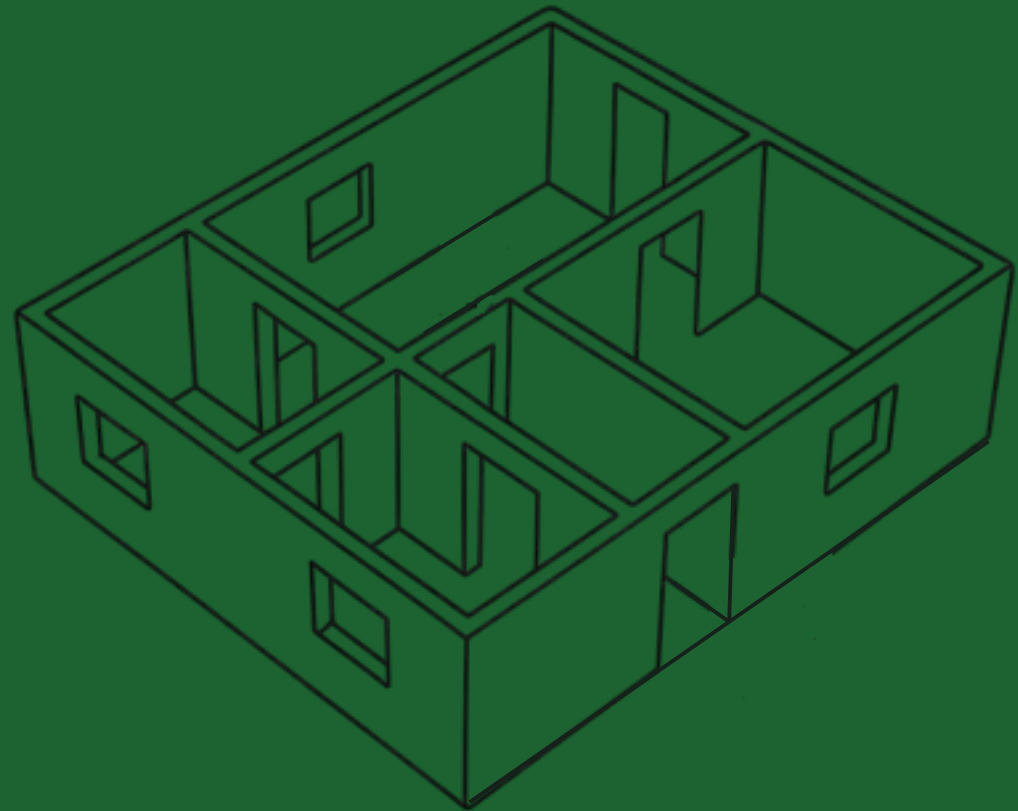

# QUICKBLOCK<sup>®</sup>

## **INSTRUCTIONS** TACTICAL TRAINING STARTER KIT CQB TRAINING SCENARIO



Follow the QUICKBLOCK instructions when building ensuring all blocks are locked firmly in place.

Use hard hats, eye protection, and appropriate footwear during construction.

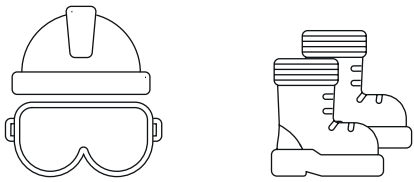

Be aware of fingertraps when opening and closing the blocks, we recommend users wear gloves when building with QUICKBLOCK.

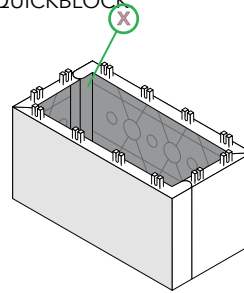

Do not construct above 12 blocks in height without advice from qualified personnel.

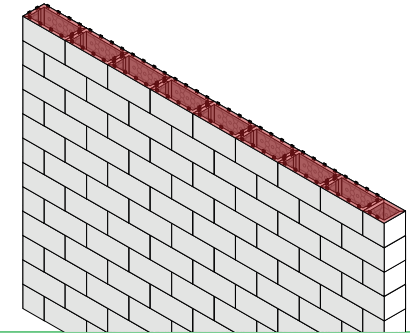

For long walls, strengthen with right angles buttressing (at 2m intervals) or integrate rooms / corners to provide stability.

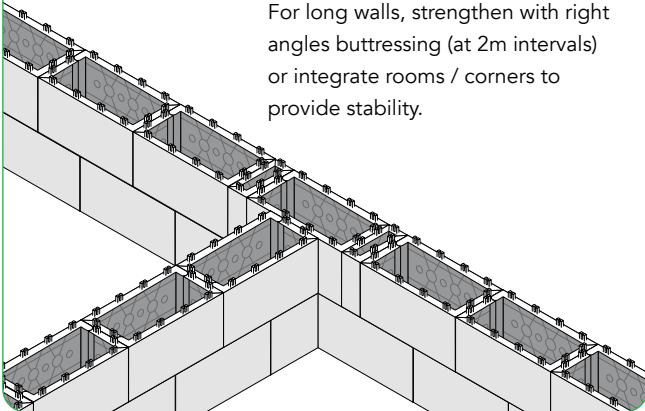

Do not climb or place heavy loads on QUICKBLOCK walls unless rated for it.

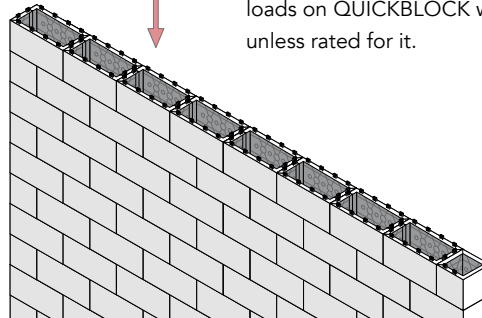

Where possible, construct on level and stable ground.

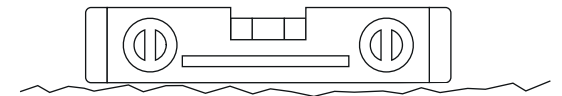

Avoid using blocks in ways not intended by the manufacturer. For more info, see the instruction manual.



## OPEN

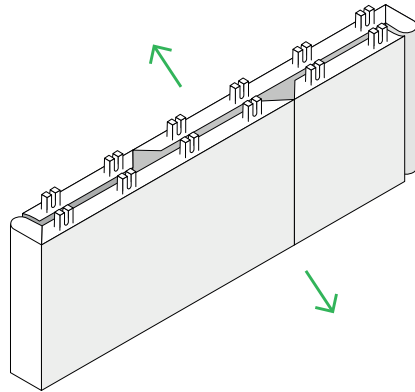

## CLICK

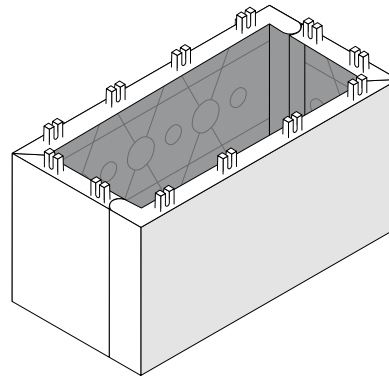

## BUILD

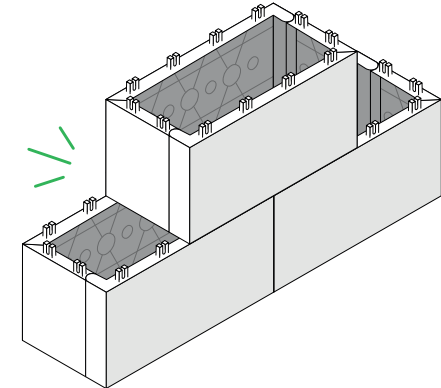

Opening blocks with excess force may result in blocks becoming damaged. It is recommended that blocks are opened with two hands and moderate force. QUICKBLOCK does not accept responsibility for blocks that are broken due to user error.



## CQB TRAINING SCENARIO

### TACTICAL TRAINING STARTER KIT

QUICKBLOCK Tactical Training Kits are designed to be assembled layer by layer, guiding you step-by-step through a straightforward and intuitive build process.

- Block type key is included on each page.
- 'How to' for building lintels for the doors included.

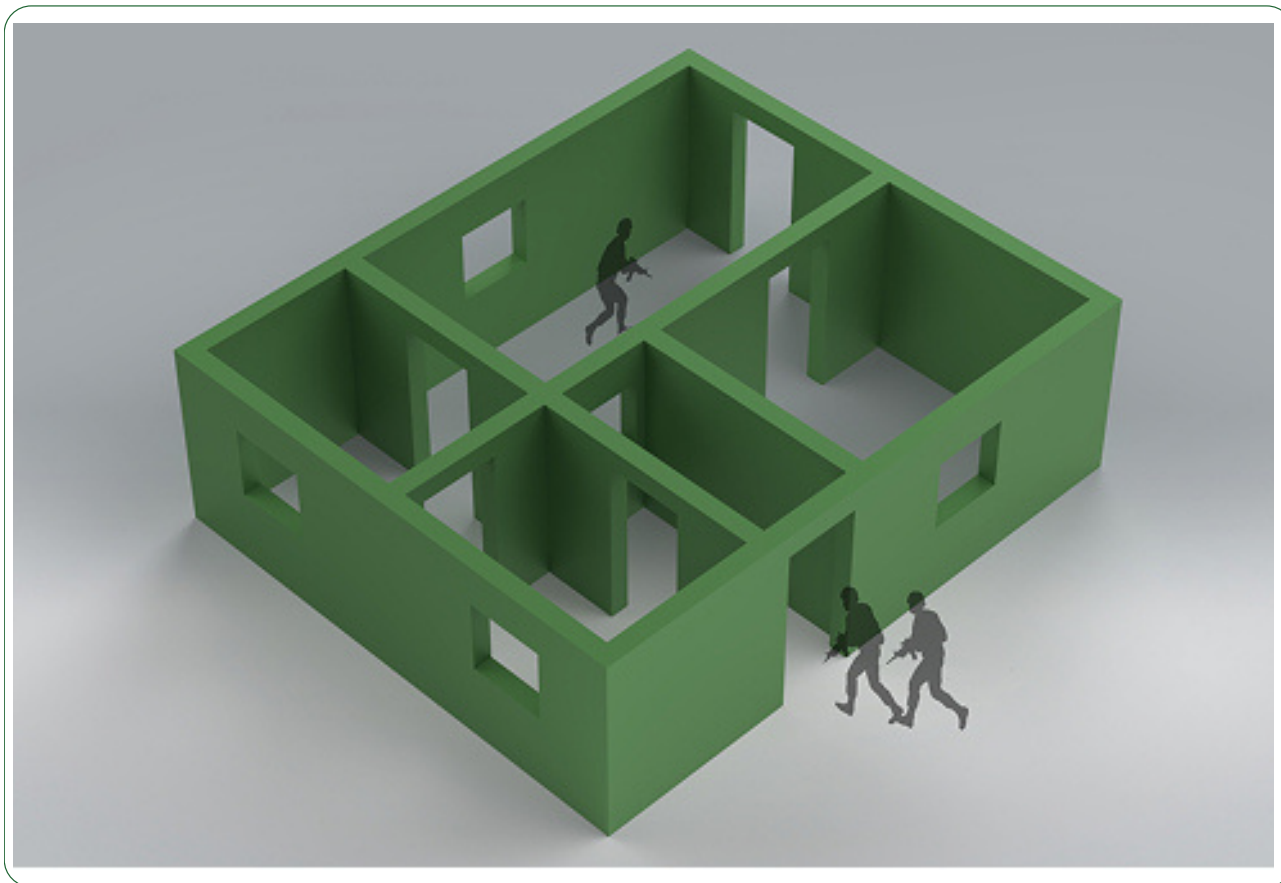

STEP 1 - FIRST LAYER

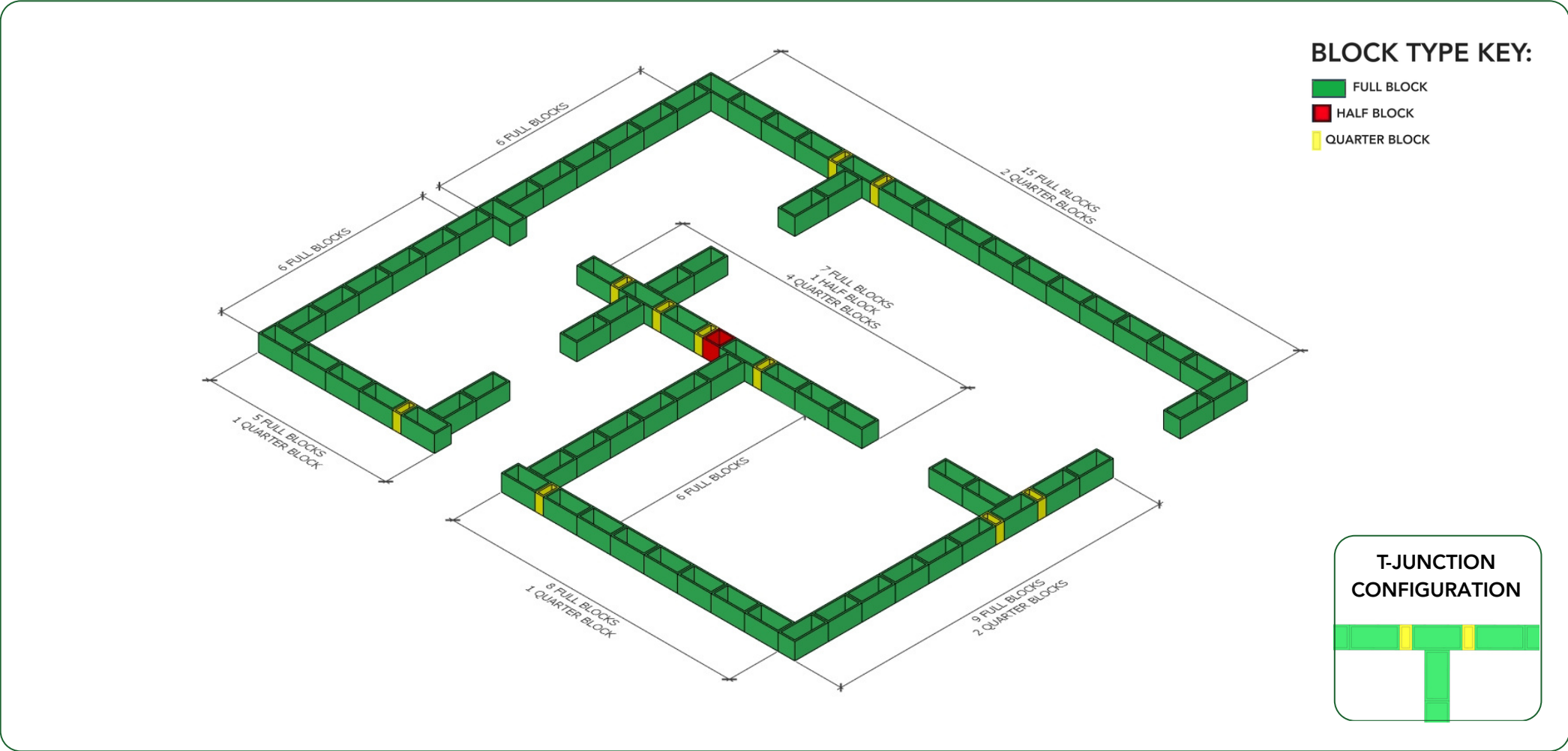

Build the first layer as above on flat ground.



STEP 2 - LAYER 2

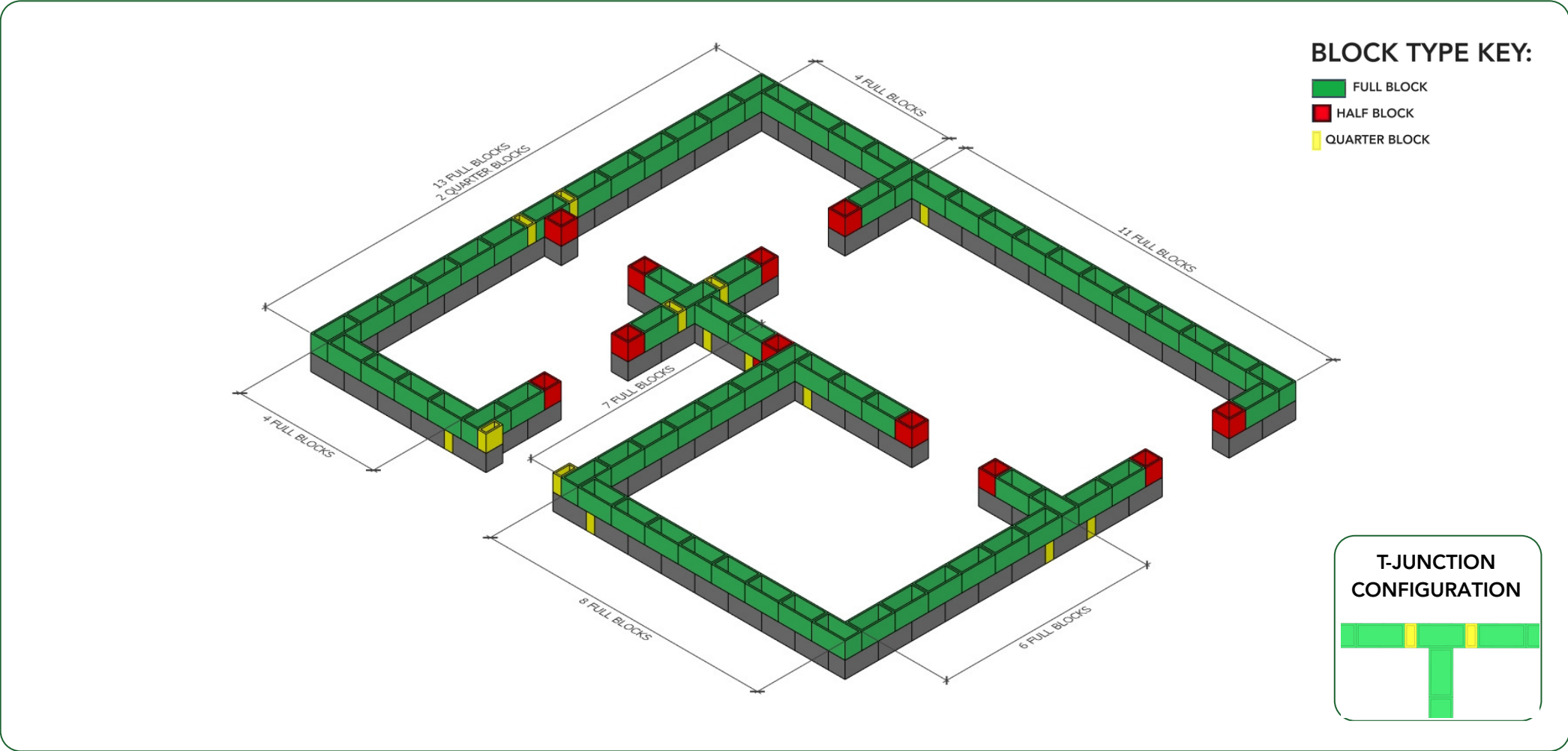

STEP 3 - LAYER 3

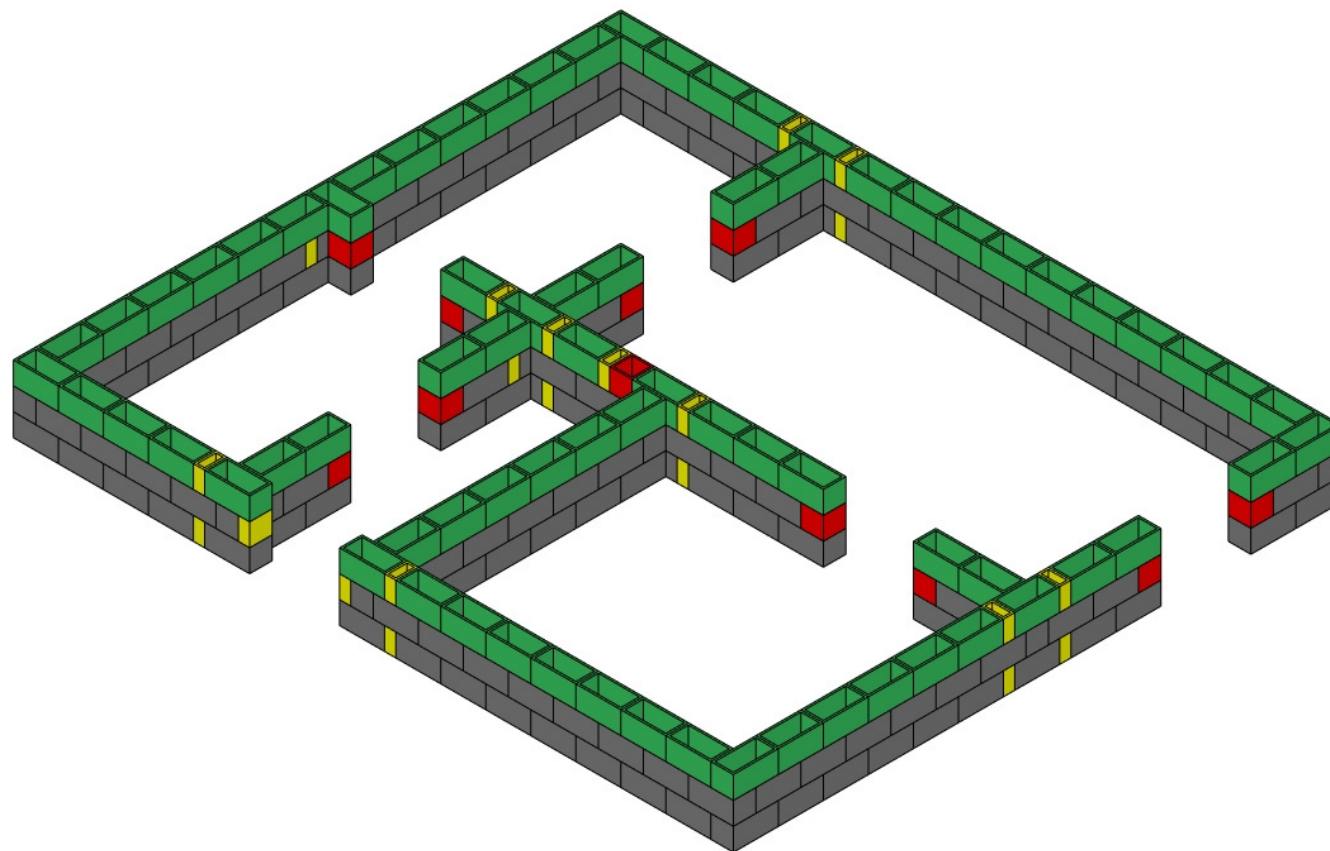

BLOCK TYPE KEY:

- FULL BLOCK
- HALF BLOCK
- QUARTER BLOCK



STEP 4 - LAYER 4

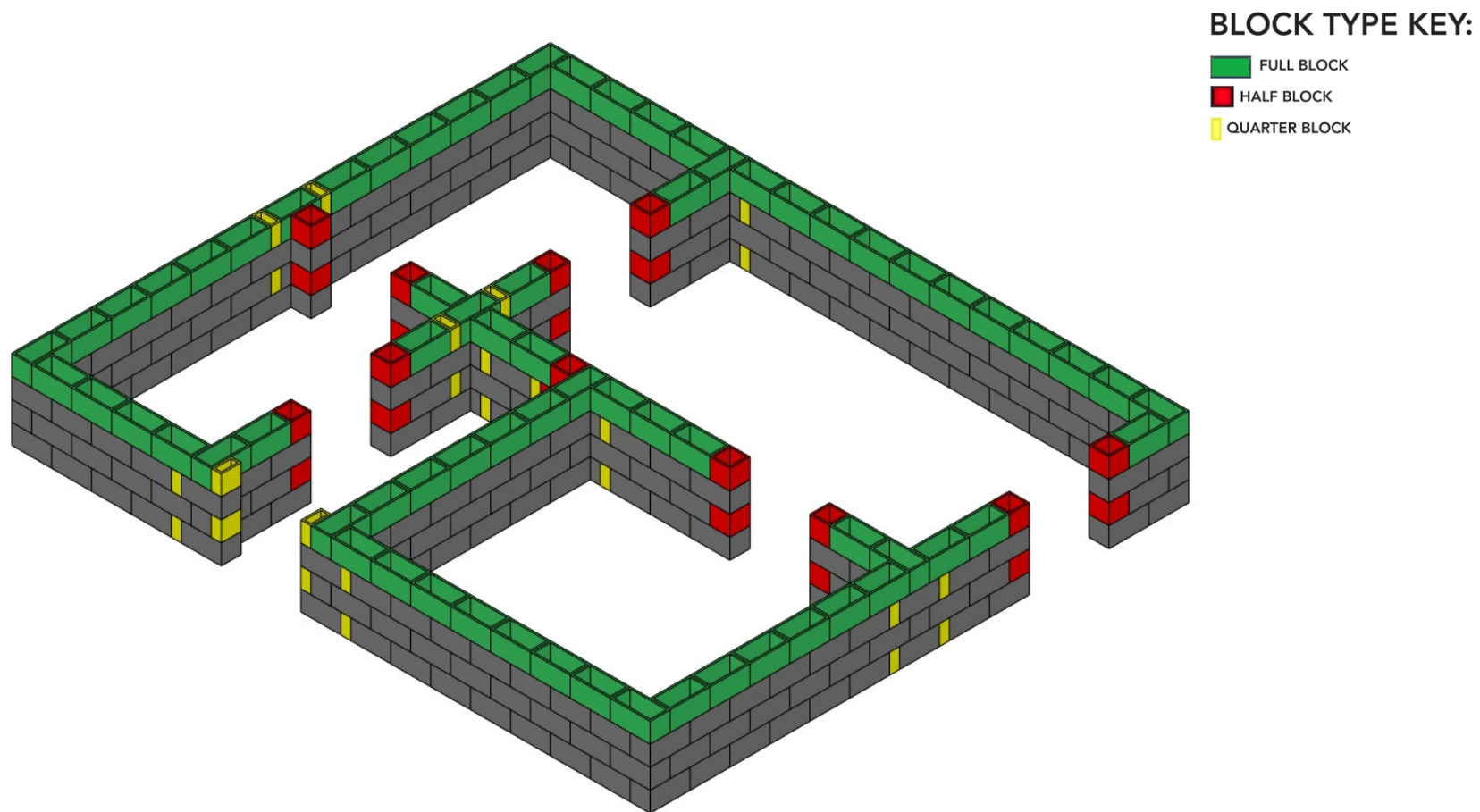

STEP 5 - LAYER 5

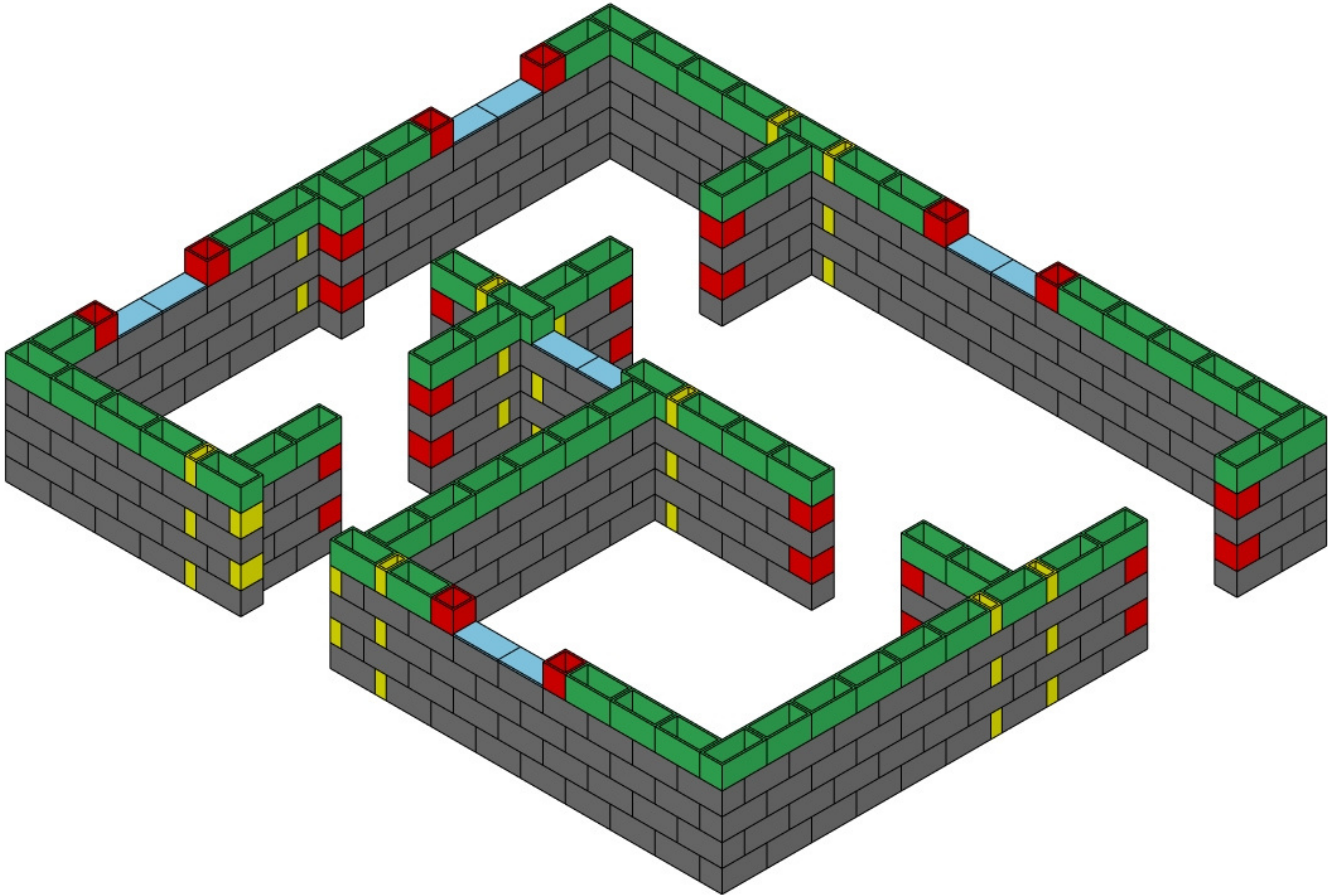

BLOCK TYPE KEY:

- FULL BLOCK
- HALF BLOCK
- QUARTER BLOCK
- CAPPING PIECE

CAPPING PIECE



STEP 6 - LAYER 6

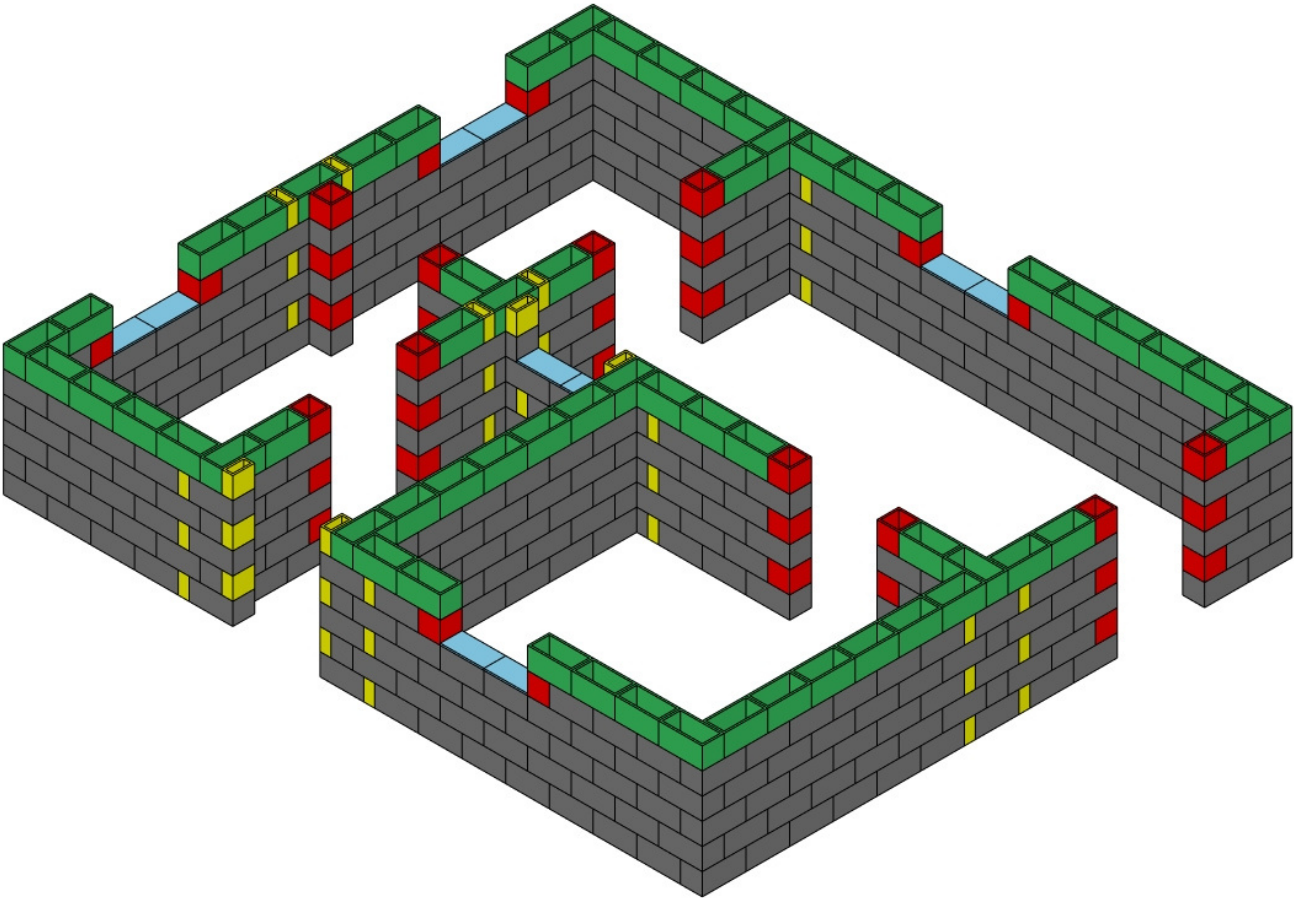

BLOCK TYPE KEY:





- FULL BLOCK
- HALF BLOCK
- QUARTER BLOCK
- CAPPING PIECE

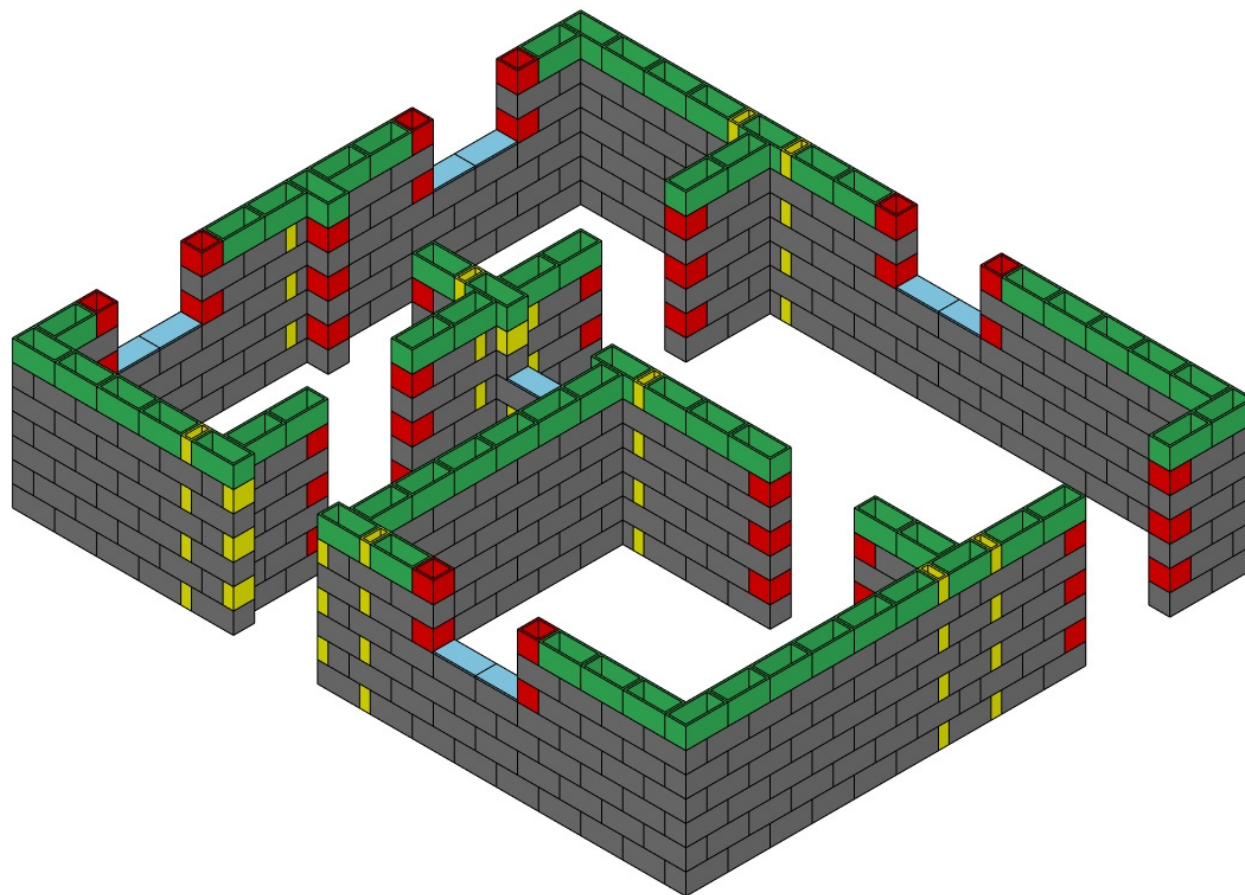

STEP 7 - LAYER 7



**BLOCK TYPE KEY:**

-  FULL BLOCK
-  HALF BLOCK
-  QUARTER BLOCK
-  CAPPING PIECE



## PREPARING CAPPING PIECES FOR LINTELS



Detailed lintel instruction pack is included with your kit.

### STEP 8

Flip Capping Piece over, revealing slots. Push 8 QUICKBLOCK clips down into the slots around outside of capping piece as shown.

### STEP 9

Push 8 QUICKBLOCK pins into corresponding holes around the outside of the Capping Piece. Make sure the head of pin sits flush with the surface around it.

### STEP 10

Create 16 lintel Capping Pieces for this structure

8

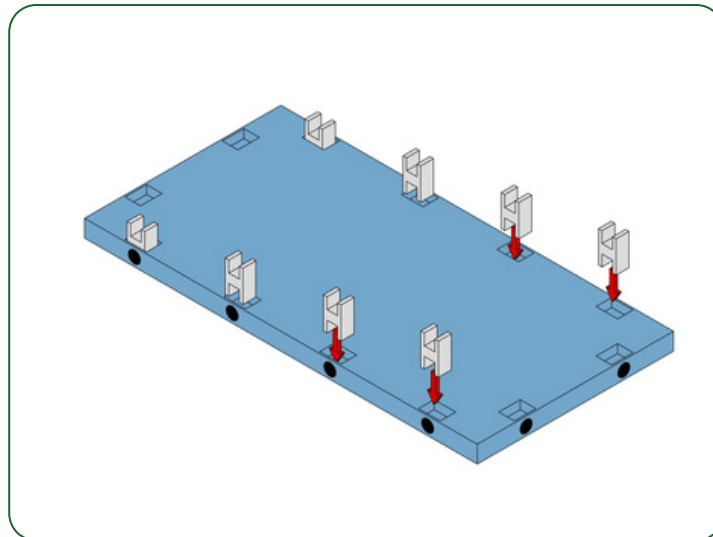

9

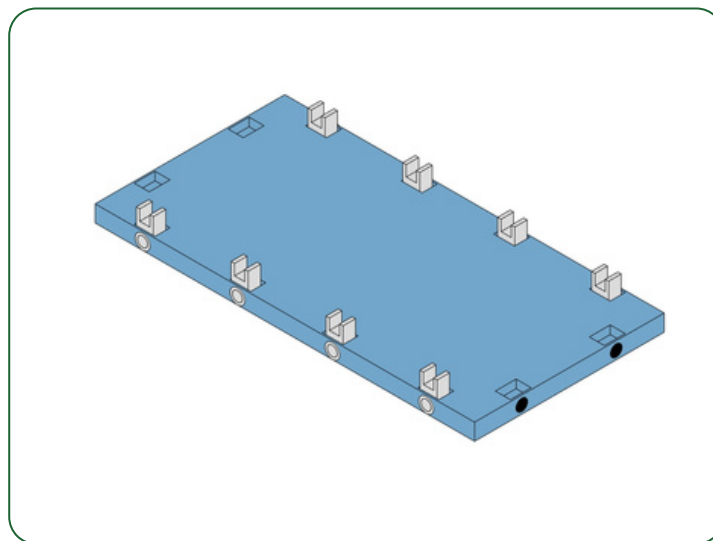
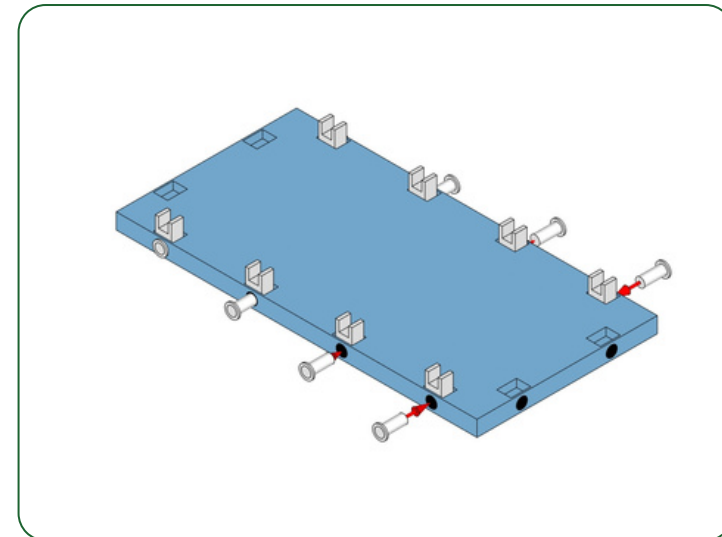

10

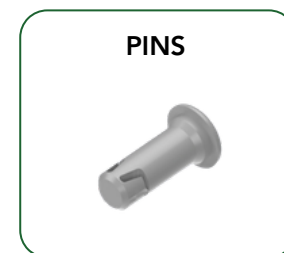
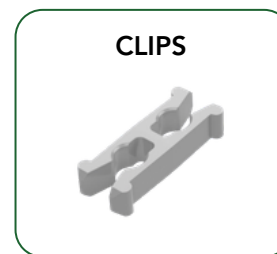

## CREATING DOOR/WINDOW LINTELS



The door and window lintels are the same size, you need to make 10.

### STEP 11

Insert 2 lintel Capping Pieces prepared previously into underside of three Full Blocks, in bricklaying style as shown.

### STEP 12

Look down into the door lintel from above. Using 16 QUICKBLOCK Pins, secure the points at which the clips come up and into the blocks, by pushing the pins through the hole and clip in locations shown.

### STEP 13

Using 20 of the lintel Capping Pieces previously created, and 30 Full Blocks, construct 10 of these door lintels.

11

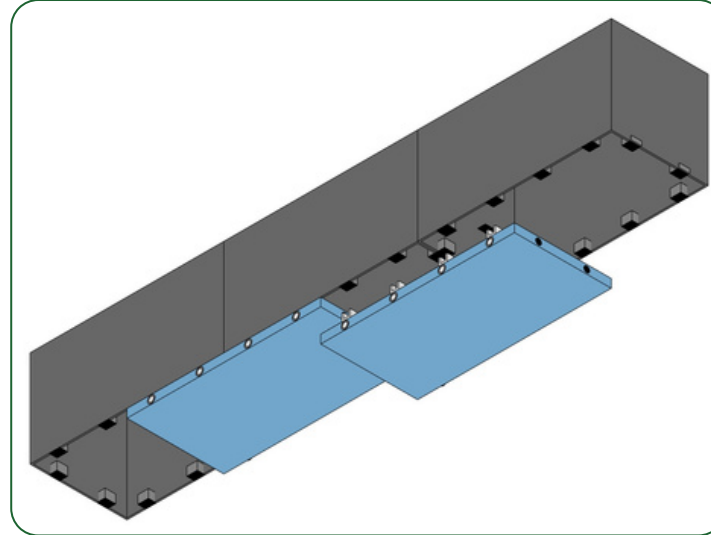

12

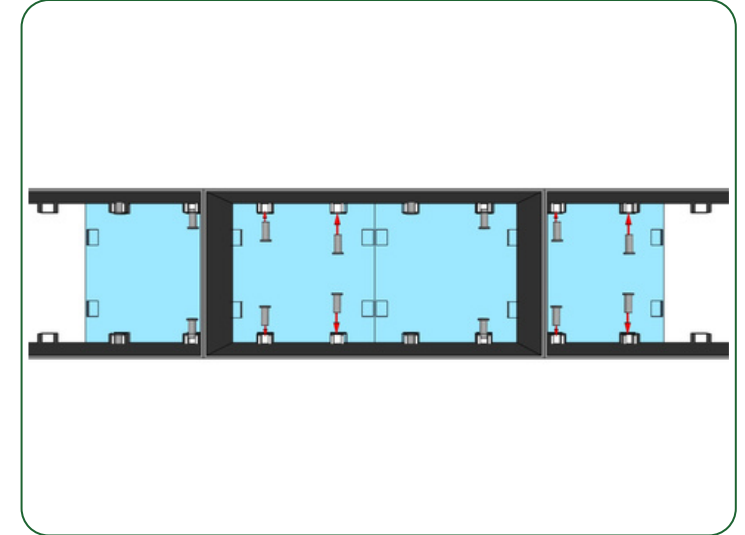

TOP OF BLOCK VIEW

13

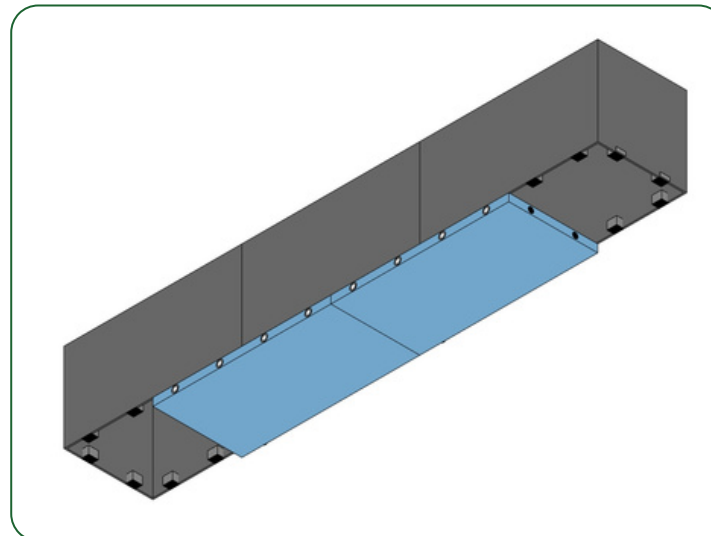

UNDERSIDE OF BLOCK VIEW

## LINTEL LOCATIONS

### STEP 14



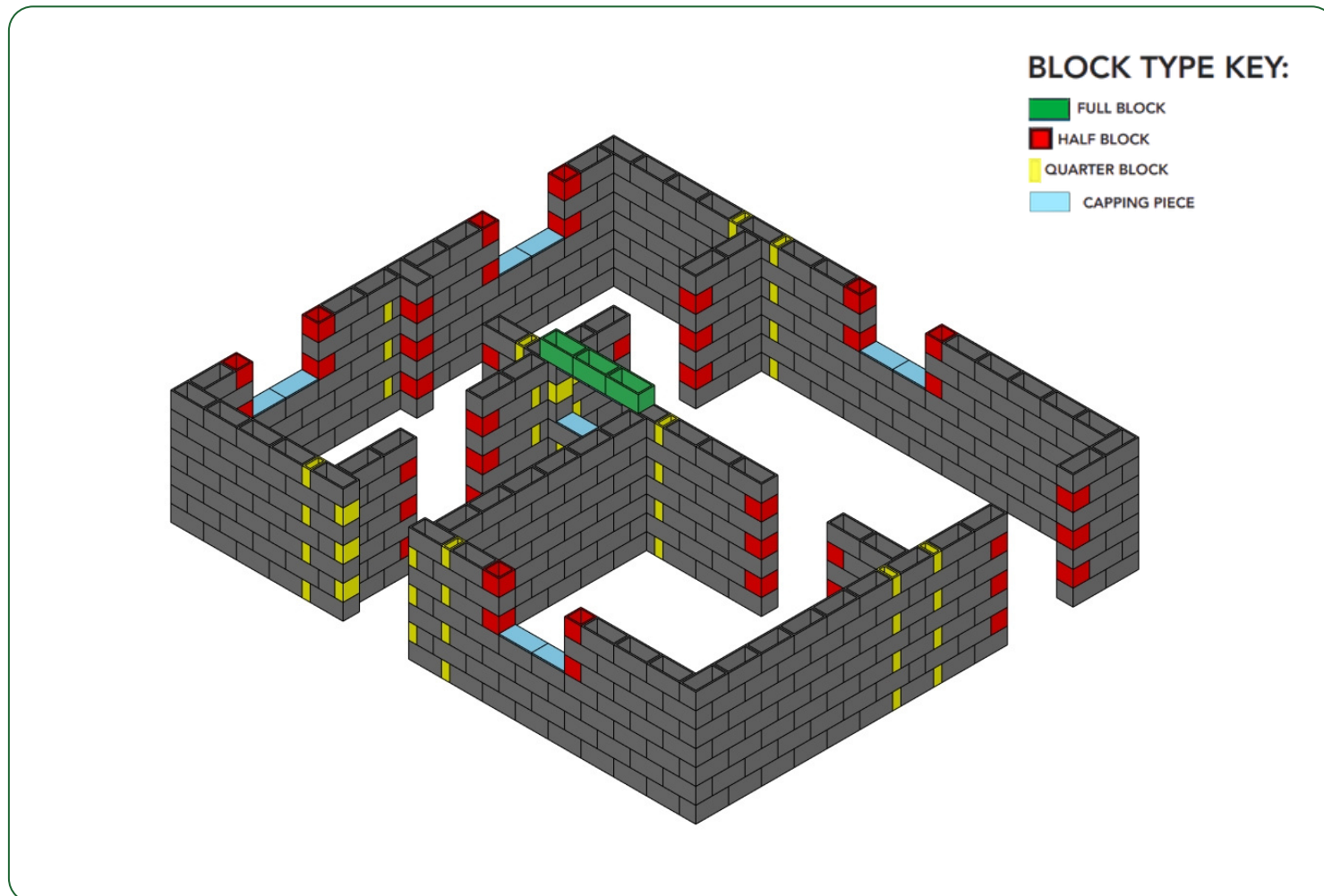

Place pre-made window lintels across window spaces, where shown.

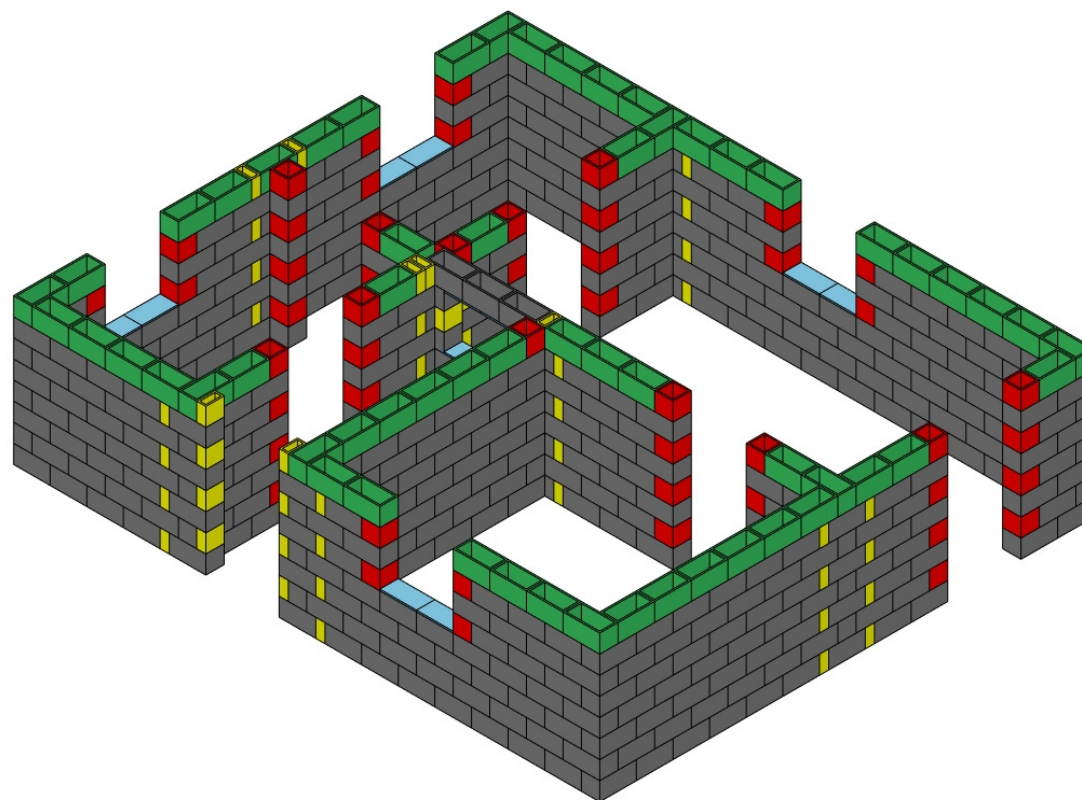

STEP 15 - LAYER 8



**BLOCK TYPE KEY:**

-  FULL BLOCK
-  HALF BLOCK
-  QUARTER BLOCK
-  CAPPING PIECE



## WINDOW LINTEL LOCATIONS

### STEP 16

Place pre-made window lintels across window spaces, where shown.

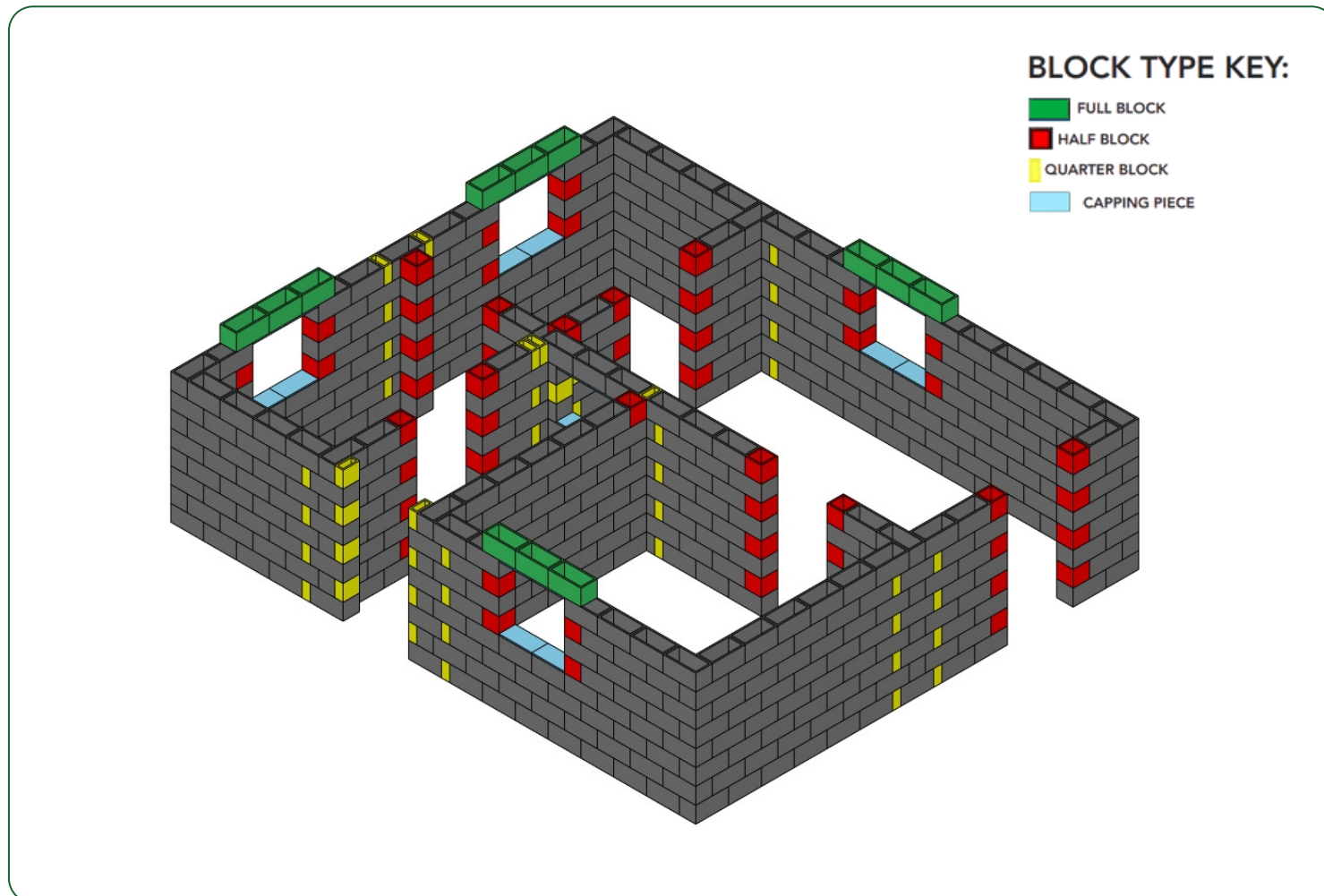

STEP 17 - LAYER 9

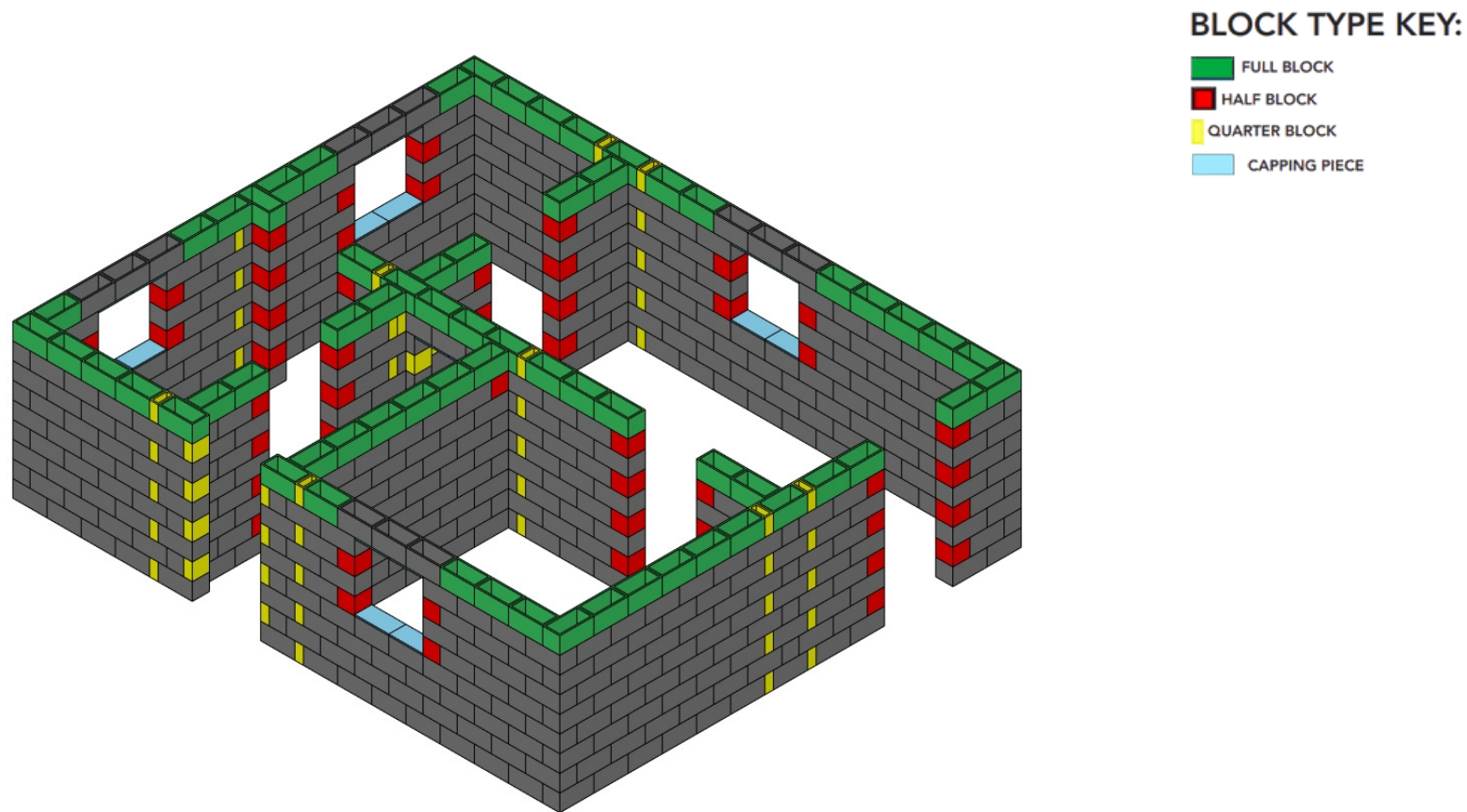

## DOOR LINTEL LOCATIONS

### STEP 18



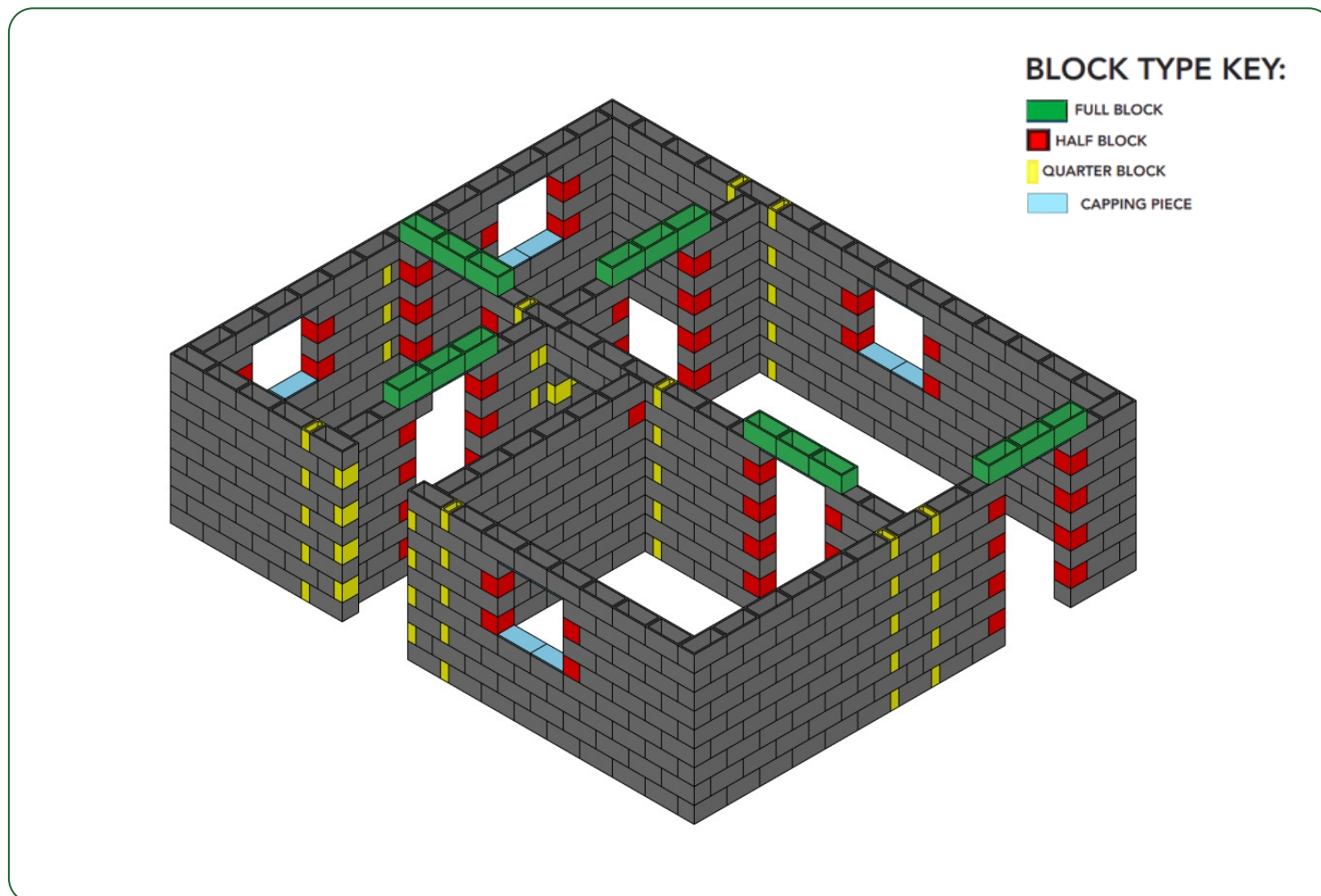

Place pre-made window lintels across window spaces, where shown.

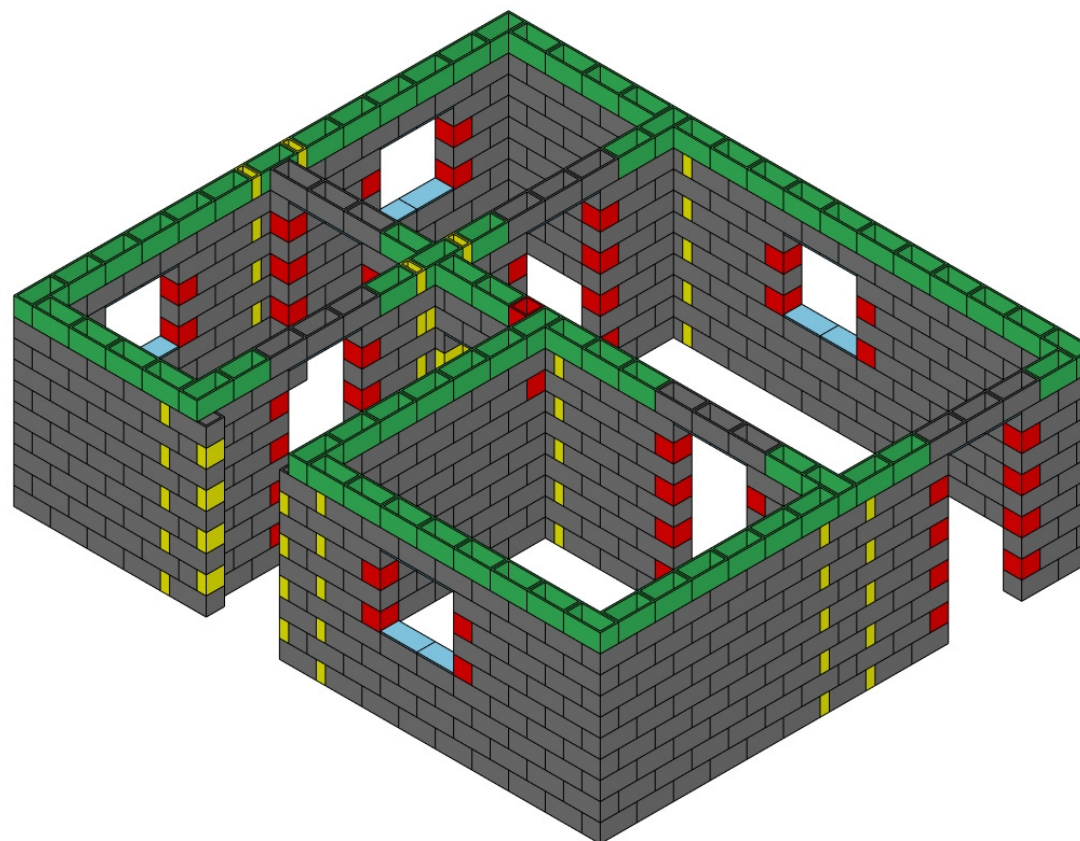

STEP 19 - LAYER 10



**BLOCK TYPE KEY:**

-  FULL BLOCK
-  HALF BLOCK
-  QUARTER BLOCK
-  CAPPING PIECE



## CAPPING PIECE LAYOUT



To create a Half-Block Capping Piece, simply snap a full Capping Piece over your knee.

### STEP 20

Place Capping Pieces over top of fixing plates in the layout shown here.

